



DieMax XL™ Maximum Life Springs

◆ Meets ISO Standards



DieMax XL™

Maximum Life Springs

SERVICE WE DELIVER AND QUALITY YOU CAN DEPEND ON

DANLY IEM is a leading manufacturer of die and mold components supplied globally to the parts forming industry. Backed by years of tool and die experience, quality and innovation are some of the reasons why our name is respected throughout the world. We have taken the lead role in creating and bringing new products to customers and helping them find solutions that improve their operations. Based on the capabilities **DANLY IEM** offers, we can help you to meet the demands of quick deliveries, technical support, quality products and competitive prices. **DANLY IEM** and its' broad distribution channels and direct sales personnel will assist you in any way to make your product a better and more profitable one.

Whether standard or customized products, with our years of experience, customers can be sure the products they receive will meet their expectations for reliability and dependable performance. We understand the demanding schedules of die builders and production personnel and have developed efficient manufacturing processes to shorten product lead times as well as put inventory on our shelves so you can have it in your facility when you need it. Put the **DANLY IEM** network to work for you. We've got the service you've been looking for.

Included in our full line offering are both inch and metric size die components that are designed to numerous die standards including ISO, NAAMS, JIS and many large automotive and appliance manufacturers' standards. The complete product offering includes:

- Accu-Bend™ Rotary Benders
- Air Presses
- Cams
 - Aerial & Diemount Cams
 - Box Cams
 - Roller Cams
 - Wide Cams
- Die Accessories
- Guide Posts & Bushings
 - Plain & Ball Bearing Styles
 - Steel, Bronze, Bronze-Plated & Self-Lubricating Bushings
 - Lempcoloy Bushings
 - Special Pins, Bushings & Retainers
- Hydraulics
 - Electronic Die Setters
 - Die Separators
 - Drill & Tap Equipment
 - Hydraulic Motors
- In-Die Tapping Units
- Mold Components
 - Bronze Plated & Self-Lubricated Bushings
 - Leader Pins
 - Bronze & Bronze Plated Wear Strips & Ways
- Punches, Buttons & Retainers
- Springs
 - DieMax L Inch Series Springs
 - DieMax XL Series ISO Springs
 - JIS Series Springs
 - Custom Heavy Duty Springs
 - Marsh Mellow Springs
 - Formathane Urethane
 - Kaller Gas Springs
 - Utility & Disc Springs
- Wear Products
 - Plates, Strips, Gibs & Blocks
 - Steel, bronze, Bronze-Plated and Self-Lubricating Materials

DieMax XL™ Maximum Life Springs

TABLE OF CONTENTS

PAGE NUMBER

General Information	2
Spring Selection Steps	4
Inch Standard	6
ISO Metric Standard	14
Round Wire Die Springs	22
Spring Accessories	24
Quote Sheet	27

Custom Die Springs

Compression springs can be made to unique physical characteristics such as shaped wire, special material, and with critical tolerance. They can also be manufactured to military specs and can include special inspections and certified testing.



JIS Springs

JIS die springs are manufactured and color coded to the Japanese Industrial Standard. The product line consists of five load ratings: Extra Light, Light, Medium, Heavy and Extra Heavy loads.

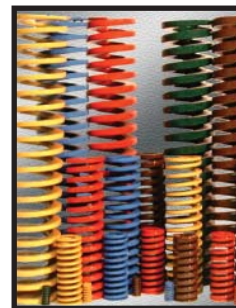

DieMax XL™ Maximum Life Springs

Four load classifications - in standard ISO sizes for dies, jigs, fixtures, and general tool work.

DANLY IEM springs are offered in a range of lengths, diameters, and load classifications that conform to the ISO 10243 International Standard and the NAAMS (North American Automotive Metric Standard), including color coding for easy identification of load range.

ISO 9002 Registered Quality

All of our **DANLY IEM** die springs are manufactured to ISO 9001: 2008 quality standards consistent with the **DANLY IEM** reputation for providing the stamping industry with the most

carefully engineered die sets and diemakers' supplies. Comparison testing of the operating life of **DANLY IEM** die springs and competitive products have shown that **DANLY IEM** springs offer significantly longer life.

The exceptional quality of **DANLY IEM** die springs has made them popular for a wide variety of applications. For example, **DANLY IEM** die springs are commonly used in general tool work, such as jigs and fixtures, as well as in industrial clutches and brakes and as components in farm machinery and aircraft mechanisms.

Many manufacturers specify **DANLY IEM** die springs because the quality and service life of these springs improves the reliability and performance of their products.

Whatever your application might be, you can be sure that the springs you select from this catalog will consistently provide rugged, dependable spring performance. They will live up to the **DANLY IEM** reputation for quality and value.

For help with your selection, or to order die springs, contact **DANLY IEM** or your authorized **DANLY IEM** distributor.



LIGHT LOAD
Green Color Coded



MEDIUM LOAD
Blue Color Coded



HEAVY LOAD
Red Color Coded



EXTRA HEAVY LOAD
Yellow Color Coded

DieMax XL™ Maximum Life Springs

DieMax XL™ Maximum Life Springs - springs you can rely on.

A combination of enhanced raw material, optimal spring design, innovative manufacturing processes, and broad distribution channels allow the DieMax XL™ spring to yield the best, most dependable performance and availability combination, time after time.

Spring Wire

Manufactured from spring quality chromium silicon alloy steel in accordance with ASTM A1000-99 specifications. The high tensile strength and superior heat resistance wire characteristics contribute to the low-stress, long life spring design.

Enhanced Design

Our spring starts with a modified trapezoidal cross section and changes to a “D” cross section after coiling. This wire cross section, exclusive to

DANLY IEM, has significantly lower stress levels during compression compared to competitor designs. The “D” cross section also allows for more coils per spring while providing a greater amount of spring travel to solid when compared to competitor springs.

Physical Dimensions and Load Ratings

Computer controlled coiling and spring setting equipment allow tight control over the critical spring characteristics. Every manufactured lot of DieMax XL™ springs is carefully inspected for hole/rod fit, free length, spring rate, solid height, squareness and physical appearance. All inspection results are recorded and analyzed to ensure compliance to quality standards. These tight tolerances and highly inspected attributes

guarantee the springs will work freely over the rods or freely in the holes specified without binding. They also ensure that the free lengths, solid heights and spring loads are compatible from spring to spring and lot to lot for predictable, long-life performance.

Manufacturing Processes

In addition to the optimal, low-stress spring design, the continual investment in the most advanced coiling and spring processing equipment allows **DANLY IEM** to offer a premium, long-life, mechanical spring solution. From the computer controlled spring coilers with in-line SPC data collection, the springs are routed through a series of steps including shot peening to reduce working stresses, and set removal which ensures the spring length and load will not relax in the tool.



Coilers - Using the latest in CNC coiling technology, springs are produced with much better predictability and consistency in performance, rates and lengths.



SPC Quality Assurance - Using SPC software, operators insure that every production process meets our high quality standards.



Computer Controlled Spring Testing - Utilizing custom software, spring testers track and verify consistency in spring dimensions and rates.

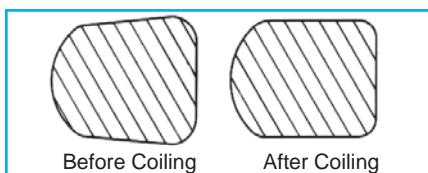

Modified trapezoidal cross section of rectangular wire springs changes to a “D” cross section during coiling to achieve a low stress level that means longer spring life.



Ends of each spring are closed and ground square to assure that the spring will stand on either end and provide a maximum bearing surface.

Spring Selection Steps

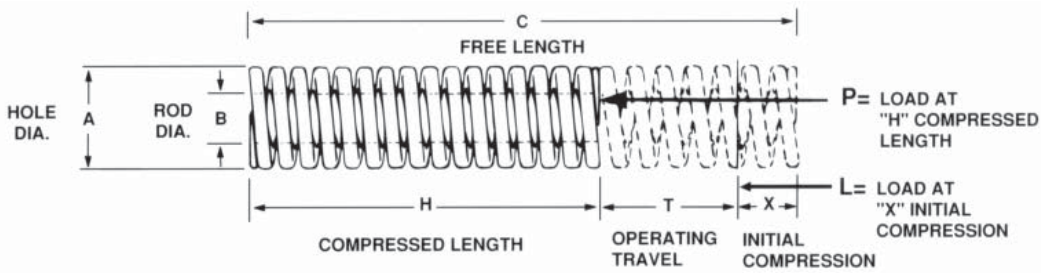

If the diameter and length are known, turn directly to dimension tables on pages 6 through 23 to select springs with desired total load.

If diameter and length are not known, use the following seven spring selection steps and refer to the rate column of the dimension tables for spring selection.

In determining the length of a spring, it should be remembered that maximum delivered spring load is obtained by selecting longer springs. For best economy and saving of space, choose Light and

Medium Load springs or the Heavy Load spring having a free length equal to six times the travel, or an Extra Heavy Load spring having a free length equal to eight times the travel. If ratios lower than these are used because of height limitations, the number of springs required will be substantially increased.

Step 1

Estimate the level of production required of the die - short run, constant production, etc.

Step 2

Determine compressed spring length "H" and operating travel "T" from the die layout.

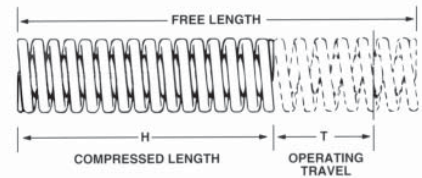

THIS CHART CONVERTS COMPRESSED LENGTHS TO FREE LENGTHS

INCH	C Free Length (in)	LIGHT LOAD			MEDIUM LOAD			HEAVY LOAD			EXTRA HEAVY LOAD		
		H-COMPRESSED LENGTH (in)			H-COMPRESSED LENGTH (in)			H-COMPRESSED LENGTH (in)			H-COMPRESSED LENGTH (in)		
		Long Life 25%	Average Life 30%	Maximum Deflection 40%	Long Life 25%	Average Life 30%	Maximum Deflection 37.5%	Long Life 20%	Average Life 25%	Maximum Deflection 30%	Long Life 17%	Average Life 20%	Maximum Deflection 25%
3/4	0.56	0.53	0.45	0.56	0.53	0.47	0.60	0.56	0.53	0.62	0.60	0.56	
1	0.75	0.70	0.60	0.75	0.70	0.62	0.80	0.75	0.70	0.83	0.80	0.75	
1 1/4	0.94	0.87	0.75	0.94	0.87	0.78	1.00	0.94	0.87	1.04	1.00	0.94	
1 1/2	1.12	1.05	0.90	1.12	1.05	0.93	1.20	1.12	1.05	1.25	1.20	1.12	
1 3/4	1.31	1.22	1.05	1.31	1.22	1.09	1.40	1.31	1.22	1.45	1.40	1.31	
2	1.50	1.40	1.20	1.50	1.40	1.25	1.60	1.50	1.40	1.66	1.60	1.50	
2 1/2	1.87	1.75	1.50	1.87	1.75	1.56	2.00	1.87	1.75	2.07	2.00	1.87	
3	2.25	2.10	1.80	2.25	2.10	1.87	2.40	2.25	2.10	2.50	2.40	2.25	
3 1/2	2.62	2.45	2.10	2.62	2.45	2.18	2.80	2.62	2.45	2.91	2.80	2.62	
4	3.00	2.80	2.40	3.00	2.80	2.50	3.20	3.00	2.80	3.33	3.20	3.00	
4 1/2	3.37	3.15	2.70	3.37	3.15	2.81	3.60	3.37	3.15	3.75	3.60	3.37	
5	3.75	3.50	3.00	3.75	3.50	3.12	4.00	3.75	3.50	4.15	4.00	3.75	
5 1/2	4.13	3.85	3.30	4.13	3.85	3.44	4.40	4.13	3.85	4.57	4.40	4.13	
6	4.50	4.20	3.60	4.50	4.20	3.75	4.80	4.50	4.20	5.00	4.80	4.50	
7	5.25	4.90	4.20	5.25	4.90	4.37	5.60	5.25	4.90	5.83	5.60	5.25	
8	6.00	5.60	4.80	6.00	5.60	5.00	6.40	6.00	5.60	6.66	6.40	6.00	
9	-	-	-	6.75	6.30	5.62	-	-	-	-	-	-	
10	7.50	7.00	6.00	7.50	7.00	6.25	8.00	7.50	7.00	8.30	8.00	7.50	
12	9.00	8.40	7.20	9.00	8.40	7.50	9.60	9.00	8.40	10.00	9.60	9.00	

Spring Selection Steps

Step 3

Determine free length "C" as follows: Decide which load classification the spring should be selected from: Light, Medium, Heavy, or Extra-Heavy Load. Then choose the figure nearest the compressed length "H" required by the die design from the appropriate charts below on pages 4 and 5. Read corresponding "C" (free length).

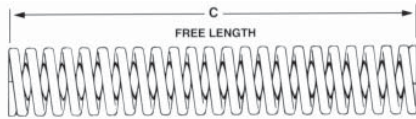

Step 4

Estimate total initial spring load "L" required for all springs when springs are compressed "X" inches or millimeters.

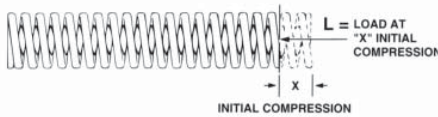

Step 5

Determine "X" (initial compression) by using the following formula:

$$X = C - H - T$$

Step 6

Inch: Determine "R" (total rate for all springs in pounds per 1/10 inch) by using the following formula:

$$R = \frac{L}{10xX}$$

Metric: Determine "R" (total rate for all springs in newtons per millimeter) by using the following formula:

$$R = \frac{L}{X}$$

Step 7

Select springs as follows:

1. The free length "C" must comply with the length determined in Step 3.
2. Divide "R" in Step 6 by the number of springs to be used (if known) in order to get the rate per spring. Then refer to the following pages for the catalog number of springs having the desired rate. If the number of springs is not known, divide "R" from Step 6 by the rate of the spring you select for the correct number of springs.

THIS CHART CONVERTS COMPRESSED LENGTHS TO FREE LENGTHS

METRIC	C Free Length (mm)	LIGHT LOAD			MEDIUM LOAD			HEAVY LOAD			EXTRA HEAVY LOAD		
		H-COMPRESSED LENGTH (mm)			H-COMPRESSED LENGTH (mm)			H-COMPRESSED LENGTH (mm)			H-COMPRESSED LENGTH (mm)		
		Long Life 25%	Average Life 30%	Maximum Deflection 40%	Long Life 25%	Average Life 30%	Maximum Deflection 37.5%	Long Life 20%	Average Life 25%	Maximum Deflection 30%	Long Life 17%	Average Life 20%	Maximum Deflection 25%
19	14	13	11	14	13	12	15	14	13	16	15	14	
25	19	18	15	19	18	16	20	19	18	21	20	19	
32	24	22	19	24	22	20	26	24	22	27	26	24	
38	29	27	23	29	27	24	30	29	27	32	30	29	
44	33	31	26	33	31	28	35	33	31	37	35	33	
51	38	36	31	38	36	32	41	38	36	42	41	38	
64	48	45	38	48	45	40	51	48	45	53	51	48	
76	57	53	46	57	53	47	61	57	53	63	61	57	
89	67	62	53	67	62	56	71	67	62	74	71	67	
102	76	71	61	76	71	64	82	76	71	85	82	76	
114	86	80	68	86	80	71	91	86	80	95	91	86	
127	95	89	76	95	89	79	102	95	89	105	102	95	
140	105	98	84	105	98	87	112	105	98	116	112	105	
152	114	106	91	114	106	95	122	114	106	126	122	114	
178	133	125	107	133	125	111	142	133	125	148	142	133	
203	152	142	122	152	142	127	162	152	142	168	162	152	
229	—	—	—	172	160	143	—	—	—	—	—	—	
254	190	178	152	190	178	159	203	190	178	211	203	190	
305	229	213	183	229	213	191	244	229	213	253	244	229	

DieMax XL™ Light Load Springs

Product Features:

- ◆ ISO color - Green
- ◆ High tensile strength chrome silicon material
- ◆ Optimal rectangular wire design
- ◆ Long life design for increased spring run-time

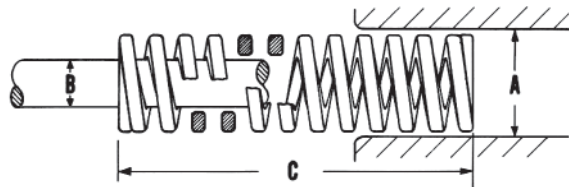

Hole Diam. (in) A	Rod Diam. (in) B	Free Length (in) C	CATALOG NUMBER	RATE Pounds Req'd. to deflect 1/10 in.	LOAD-DEFLECTION TABLE									
					Total Deflection Recommended for Long Life (25% of C)		Total Deflection Recommended for Avg. Life (30% of C)		Maximum Operating Deflection (40% of C)		Total Travel to Solid			
					Load lbs.	Defl. in.	Load lbs.	Defl. in.	Load lbs.	Defl. in.	Load lbs.	Defl. in.		
3/8	3/16	3/4	9-0603-11	8.4	16	0.19	19	0.23	25	0.30	32	0.38		
		1	9-0604-11	6.3	16	0.25	19	0.30	25	0.40	35	0.52		
		1 1/4	9-0605-11	5.0	16	0.31	19	0.38	25	0.50	36	0.67		
		1 1/2	9-0606-11	4.2	16	0.37	19	0.45	25	0.60	37	0.80		
		1 3/4	9-0607-11	3.6	16	0.43	19	0.52	25	0.69	37	0.96		
		2	9-0608-11	3.1	15	0.50	18	0.60	25	0.80	36	1.08		
		2 1/2	9-0610-11	2.6	16	0.63	19	0.76	26	1.01	38	1.45		
		3	9-0612-11	2.1	16	0.75	19	0.90	25	1.20	39	1.70		
		12	9-0648-11	0.5	15	3.00	18	3.60	24	4.80	34	6.84		
		3/4	9-0803-11	14.5	27	0.19	33	0.23	44	0.30	57	0.39		
		1	9-0804-11	10.9	27	0.25	32	0.30	43	0.40	58	0.54		
		1/2	9/32	1 1/4	9-0805-11	9.4	30	0.31	36	0.38	47	0.50	68	0.72
1 1/2	9-0806-11			7.8	29	0.37	35	0.45	47	0.60	68	0.87		
1 3/4	9-0807-11			6.6	29	0.43	34	0.52	46	0.69	68	1.03		
2	9-0808-11			5.8	29	0.50	35	0.60	47	0.80	69	1.19		
2 1/2	9-0810-11			4.7	29	0.63	35	0.76	47	1.01	70	1.50		
3	9-0812-11			3.6	27	0.75	32	0.90	43	1.20	62	1.73		
3 1/2	9-0814-11			3.1	27	0.88	32	1.05	43	1.40	62	2.03		
12	9-0848-11			0.8	25	3.00	30	3.60	40	4.80	58	6.88		
3/4	9-1003-11			22.0	41	0.19	50	0.23	66	0.30	79	0.36		
1	9-1004-11			18.0	44	0.25	53	0.30	71	0.40	95	0.53		
5/8	11/32			1 1/4	9-1005-11	13.4	42	0.31	51	0.38	68	0.50	87	0.65
				1 1/2	9-1006-11	12.0	45	0.37	54	0.45	72	0.60	100	0.83
		1 3/4	9-1007-11	10.0	43	0.43	52	0.52	69	0.69	97	0.97		
		2	9-1008-11	9.3	47	0.50	56	0.60	75	0.80	107	1.16		
		2 1/2	9-1010-11	7.2	45	0.63	54	0.76	73	1.01	103	1.44		
		3	9-1012-11	5.9	44	0.75	53	0.90	71	1.20	103	1.74		
		3 1/2	9-1014-11	5.3	46	0.88	56	1.05	74	1.40	112	2.10		
		4	9-1016-11	4.7	47	1.00	57	1.20	75	1.61	114	2.42		
		12	9-1048-11	1.5	45	3.00	54	3.60	72	4.80	109	7.26		
		3/4	9-1203-11	42.5	80	0.19	96	0.23	128	0.30	153	0.36		
		1	9-1204-11	32.0	79	0.25	94	0.30	126	0.40	158	0.49		
		1/2	9/32	1 1/4	9-1205-11	24.4	77	0.31	92	0.38	123	0.50	152	0.63
1 1/2	9-1206-11			19.3	72	0.37	87	0.45	115	0.60	144	0.74		
1 3/4	9-1207-11			16.2	70	0.43	84	0.52	112	0.69	142	0.87		
2	9-1208-11			14.2	71	0.50	86	0.60	114	0.80	144	1.02		
2 1/2	9-1210-11			11.0	69	0.63	83	0.76	111	1.01	139	1.27		
3	9-1212-11			9.2	69	0.75	83	0.90	110	1.20	142	1.55		
3 1/2	9-1214-11			7.7	67	0.88	81	1.05	108	1.40	137	1.79		
4	9-1216-11			6.8	68	1.00	82	1.20	109	1.61	140	2.07		
4 1/2	9-1218-11			6.0	67	1.12	81	1.35	108	1.80	140	2.34		
5	9-1220-11			5.3	66	1.25	80	1.50	106	2.00	137	2.58		
5 1/2	9-1222-11			4.9	67	1.38	80	1.65	107	2.20	139	2.86		
6	9-1224-11			4.5	67	1.50	81	1.80	108	2.39	143	3.17		
12	9-1248-11	2.2	65	3.00	78	3.60	104	4.80	135	6.24				

Inch Standard

Hole Diam. (in) A	Rod Diam. (in) B	Free Length (in) C	CATALOG NUMBER	RATE Pounds Req'd. to deflect 1/10 in.	LOAD-DEFLECTION TABLE							
					Total Deflection Recommended for Long Life (25% of C)		Total Deflection Recommended for Avg. Life (30% of C)		Maximum Operating Deflection (40% of C)		Total Travel to Solid	
					Load lbs.	Defl. in.	Load lbs.	Defl. in.	Load lbs.	Defl. in.	Load lbs.	Defl. in.
1	1/2	1	9-1604-11	61.2	151	0.25	181	0.30	241	0.40	296	0.48
		1 1/4	9-1605-11	46.2	146	0.31	175	0.38	233	0.50	284	0.62
		1 1/2	9-1606-11	37.0	138	0.37	166	0.45	221	0.60	277	0.75
		1 3/4	9-1607-11	30.6	133	0.43	159	0.52	212	0.69	268	0.87
		2	9-1608-11	26.5	133	0.50	160	0.60	213	0.80	269	1.01
		2 1/2	9-1610-11	20.4	129	0.63	154	0.76	206	1.01	258	1.25
		3	9-1612-11	16.8	126	0.75	151	0.90	201	1.20	256	1.50
		3 1/2	9-1614-11	14.1	124	0.88	148	1.05	198	1.40	251	1.75
		4	9-1616-11	12.1	121	1.00	146	1.20	194	1.61	247	2.01
		4 1/2	9-1618-11	10.7	120	1.12	144	1.35	192	1.80	244	2.25
		5	9-1620-11	9.6	120	1.25	144	1.50	192	2.00	244	2.52
		5 1/2	9-1622-11	8.7	120	1.38	144	1.65	192	2.20	247	2.80
		6	9-1624-11	8.0	120	1.50	144	1.80	191	2.39	250	3.10
		7	9-1628-11	6.9	121	1.75	145	2.10	193	2.80	252	3.63
		8	9-1632-11	6.0	120	2.00	144	2.40	192	3.20	253	4.17
		12	9-1648-11	4.0	120	3.00	144	3.60	192	4.80	254	6.22
1 1/4	5/8	1 1/2	9-2006-11	57.9	217	0.37	260	0.45	346	0.60	413	0.71
		1 3/4	9-2007-11	47.5	206	0.43	247	0.52	329	0.69	397	0.84
		2	9-2008-11	40.7	204	0.50	245	0.60	327	0.80	393	0.96
		2 1/2	9-2010-11	31.4	198	0.63	237	0.76	316	1.01	382	1.22
		3	9-2012-11	26.3	197	0.75	236	0.90	315	1.20	395	1.50
		3 1/2	9-2014-11	22.2	194	0.88	233	1.05	311	1.40	391	1.76
		4	9-2016-11	19.2	193	1.00	231	1.20	308	1.61	388	2.02
		4 1/2	9-2018-11	16.9	190	1.12	228	1.35	303	1.80	386	2.28
		5	9-2020-11	15.0	188	1.25	225	1.50	300	2.00	379	2.53
		5 1/2	9-2022-11	13.5	186	1.38	223	1.65	298	2.20	374	2.77
		6	9-2024-11	12.3	184	1.50	221	1.80	294	2.39	373	3.03
				7	9-2028-11	10.4	182	1.75	219	2.10	292	2.80
		8	9-2032-11	9.1	182	2.00	218	2.40	291	3.20	366	4.04
		10	9-2040-11	7.2	180	2.50	216	3.00	288	4.00	360	5.03
		12	9-2048-11	5.9	177	3.00	213	3.60	283	4.80	357	6.03
1 1/2	3/4	2	9-2408-11	60.3	303	0.50	363	0.60	484	0.80	584	0.97
		2 1/2	9-2410-11	45.8	289	0.63	346	0.76	462	1.01	558	1.22
		3	9-2412-11	37.5	281	0.75	337	0.90	449	1.20	558	1.49
		3 1/2	9-2414-11	31.8	279	0.88	334	1.05	446	1.40	559	1.76
		4	9-2416-11	27.3	274	1.00	329	1.20	439	1.61	547	2.01
		4 1/2	9-2418-11	24.1	270	1.12	324	1.35	433	1.80	549	2.28
		5	9-2420-11	21.6	270	1.25	324	1.50	432	2.00	551	2.55
		5 1/2	9-2422-11	19.4	267	1.38	321	1.65	428	2.20	543	2.80
		6	9-2424-11	17.6	263	1.50	316	1.80	421	2.39	537	3.05
		7	9-2428-11	15.0	263	1.75	315	2.10	420	2.80	534	3.57
		8	9-2432-11	12.9	258	2.00	309	2.40	412	3.20	526	4.07
				10	9-2440-11	10.3	258	2.50	309	3.00	412	4.00
		12	9-2448-11	8.4	252	3.00	303	3.60	403	4.80	516	6.10
2	1	2 1/2	9-3210-11	89.9	566	0.63	680	0.76	906	1.01	1096	1.22
		3	9-3212-11	72.0	539	0.75	646	0.90	862	1.20	1064	1.50
		3 1/2	9-3214-11	60.2	527	0.88	633	1.05	844	1.40	1046	1.75
		4	9-3216-11	51.2	514	1.00	617	1.20	822	1.61	1016	2.02
		4 1/2	9-3218-11	44.9	504	1.12	605	1.35	806	1.80	1006	2.28
		5	9-3220-11	40.0	500	1.25	600	1.50	800	2.00	1000	2.50
		5 1/2	9-3222-11	36.0	496	1.38	595	1.65	794	2.20	994	2.76
		6	9-3224-11	32.8	491	1.50	589	1.80	785	2.39	990	3.02
		7	9-3228-11	27.8	487	1.75	584	2.10	779	2.80	983	3.54
		8	9-3232-11	23.8	476	2.00	571	2.40	761	3.20	951	4.00
		10	9-3240-11	18.8	470	2.50	564	3.00	752	4.00	950	5.04
				12	9-3248-11	15.5	465	3.00	558	3.60	744	4.80
2 1/2	1 1/2	3	9-4012-11	110.0	823	0.75	987	0.90	1317	1.20	1569	1.43
		3 1/2	9-4014-11	89.9	788	0.88	945	1.05	1260	1.40	1512	1.68
		4	9-4016-11	76.2	765	1.00	918	1.20	1224	1.61	1473	1.93
		4 1/2	9-4018-11	66.0	741	1.12	889	1.35	1185	1.80	1440	2.18
		5	9-4020-11	58.8	735	1.25	882	1.50	1176	2.00	1442	2.45
		6	9-4024-11	47.6	712	1.50	855	1.80	1139	2.39	1406	2.95
		7	9-4028-11	40.0	701	1.75	841	2.10	1121	2.80	1380	3.45
		8	9-4032-11	34.4	687	2.00	825	2.40	1100	3.20	1362	3.96
		10	9-4040-11	26.7	668	2.50	801	3.00	1068	4.00	1316	4.92
		12	9-4048-11	22.0	660	3.00	793	3.60	1057	4.80	1304	5.92

DieMax XL™ Medium Load Springs

Product Features:

- ◆ ISO color - Blue
- ◆ High tensile strength chrome silicon material
- ◆ Optimal rectangular wire design
- ◆ Long life design for increased spring run-time

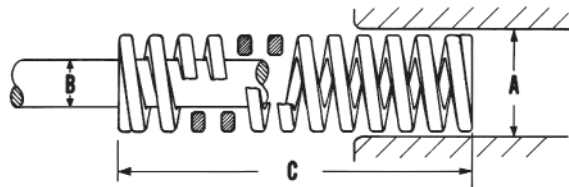

Hole Diam. (in) A	Rod Diam. (in) B	Free Length (in) C	CATALOG NUMBER	RATE Pounds Reqd. to deflect 1/10 in.	LOAD-DEFLECTION TABLE							
					Total Deflection Recommended for Long Life (25% of C)		Total Deflection Recommended for Avg. Life (30% of C)		Maximum Operating Deflection (37.5% of C)		Total Travel to Solid	
					Load lbs.	Defl. in.	Load lbs.	Defl. in.	Load lbs.	Defl. in.	Load lbs.	Defl. in.
3/8	3/16	3/4	9-0603-21	12.5	23	0.19	28	0.23	35	0.28	39	0.31
		1	9-0604-21	9.3	23	0.25	27	0.30	34	0.37	42	0.46
		1 1/4	9-0605-21	8.0	25	0.31	30	0.38	38	0.47	50	0.63
		1 1/2	9-0606-21	6.7	25	0.37	30	0.45	38	0.56	51	0.77
		1 3/4	9-0607-21	5.6	24	0.43	29	0.52	36	0.65	50	0.89
		2	9-0608-21	4.9	25	0.50	30	0.60	37	0.75	50	1.03
		2 1/2	9-0610-21	3.9	24	0.63	29	0.76	37	0.94	50	1.28
		3	9-0612-21	3.3	24	0.75	29	0.90	36	1.12	51	1.56
1/2	9/32	12	9-0648-21	0.8	23	3.00	27	3.60	34	4.50	46	6.07
		3/4	9-0803-21	21.0	39	0.19	47	0.23	59	0.28	63	0.30
		1	9-0804-21	16.5	41	0.25	49	0.30	61	0.37	82	0.50
		1 1/4	9-0805-21	12.9	41	0.31	49	0.38	61	0.47	82	0.63
		1 1/2	9-0806-21	10.9	41	0.37	49	0.45	61	0.56	86	0.78
		1 3/4	9-0807-21	9.2	40	0.43	48	0.52	60	0.65	84	0.91
		2	9-0808-21	8.0	40	0.50	48	0.60	60	0.75	85	1.06
		2 1/2	9-0810-21	6.3	40	0.63	48	0.76	60	0.94	82	1.32
5/8	11/32	3	9-0812-21	5.0	37	0.75	45	0.90	56	1.12	77	1.54
		3 1/2	9-0814-21	4.3	37	0.88	45	1.05	56	1.31	77	1.81
		12	9-0848-21	1.2	37	3.00	45	3.60	56	4.50	79	6.35
		3/4	9-1003-21	38.5	72	0.19	87	0.23	108	0.28	123	0.32
		1	9-1004-21	31.8	78	0.25	94	0.30	117	0.37	141	0.44
		1 1/4	9-1005-21	23.0	72	0.31	87	0.38	109	0.47	123	0.53
		1 1/2	9-1006-21	20.1	75	0.37	90	0.45	113	0.56	140	0.69
		1 3/4	9-1007-21	17.4	75	0.43	90	0.52	113	0.65	145	0.84
3/4	3/8	2	9-1008-21	15.4	77	0.50	93	0.60	116	0.75	151	0.98
		2 1/2	9-1010-21	12.0	76	0.63	91	0.76	113	0.94	146	1.22
		3	9-1012-21	10.1	76	0.75	91	0.90	113	1.12	153	1.51
		3 1/2	9-1014-21	8.7	76	0.88	91	1.05	114	1.31	155	1.78
		4	9-1016-21	7.6	76	1.00	92	1.20	114	1.51	154	2.04
		12	9-1048-21	2.4	71	3.00	85	3.60	106	4.50	142	6.01
		3/4	9-1203-21	68.5	128	0.19	154	0.23	193	0.28	199	0.29
		1	9-1204-21	51.5	127	0.25	152	0.30	190	0.37	208	0.40
3/4	3/8	1 1/4	9-1205-21	38.9	123	0.31	147	0.38	184	0.47	198	0.51
		1 1/2	9-1206-21	31.3	117	0.37	140	0.45	176	0.56	192	0.61
		1 3/4	9-1207-21	25.8	112	0.43	134	0.52	168	0.65	182	0.71
		2	9-1208-21	22.2	111	0.50	134	0.60	167	0.75	180	0.81
		2 1/2	9-1210-21	17.3	109	0.63	131	0.76	163	0.94	177	1.02
		3	9-1212-21	14.1	105	0.75	127	0.90	158	1.12	173	1.22
		3 1/2	9-1214-21	12.2	107	0.88	128	1.05	160	1.31	178	1.46
		4	9-1216-21	10.6	106	1.00	128	1.20	160	1.51	179	1.68
		4 1/2	9-1218-21	9.3	105	1.13	126	1.36	158	1.70	175	1.88
		5	9-1220-21	8.3	104	1.25	125	1.50	156	1.88	175	2.09
		5 1/2	9-1222-21	7.5	103	1.37	123	1.64	154	2.05	174	2.30
		6	9-1224-21	6.9	103	1.50	124	1.80	155	2.24	173	2.52
12	9-1248-21	3.5	104	3.00	125	3.60	156	4.50	180	5.21		

Inch Standard

Hole Diam. (in) A	Rod Diam. (in) B	Free Length (in) C	CATALOG NUMBER	RATE Pounds Reqd. to deflect 1/10 in.	LOAD-DEFLECTION TABLE							
					Total Deflection Recommended for Long Life (25% of C)		Total Deflection Recommended for Avg. Life (30% of C)		Maximum Operating Deflection (37.5% of C)		Total Travel to Solid	
					Load lbs.	Defl. in.	Load lbs.	Defl. in.	Load lbs.	Defl. in.	Load lbs.	Defl. in.
1	1/2	1	9-1604-21	94.9	234	0.25	280	0.30	350	0.37	371	0.39
		1 1/4	9-1605-21	71.2	224	0.31	269	0.38	336	0.47	357	0.50
		1 1/2	9-1606-21	56.3	211	0.37	253	0.45	316	0.56	338	0.60
		1 3/4	9-1607-21	47.5	206	0.43	247	0.52	309	0.65	341	0.72
		2	9-1608-21	41.0	206	0.50	247	0.60	309	0.75	344	0.84
		2 1/2	9-1610-21	31.4	198	0.63	237	0.76	297	0.94	327	1.04
		3	9-1612-21	25.8	193	0.75	232	0.90	289	1.12	325	1.26
		3 1/2	9-1614-21	21.6	189	0.88	227	1.05	284	1.31	317	1.46
		4	9-1616-21	18.8	189	1.00	226	1.20	283	1.51	316	1.68
		4 1/2	9-1618-21	16.7	189	1.13	227	1.36	284	1.70	320	1.92
		5	9-1620-21	15.0	188	1.25	225	1.50	281	1.88	320	2.14
		5 1/2	9-1622-21	13.5	185	1.37	222	1.64	277	2.05	319	2.36
6	9-1624-21	12.4	186	1.50	223	1.80	278	2.24	319	2.58		
7	9-1628-21	10.5	184	1.75	221	2.10	276	2.63	314	3.00		
8	9-1632-21	9.1	182	2.00	218	2.40	273	3.00	312	3.42		
12	9-1648-21	6.0	180	3.00	216	3.60	270	4.50	305	5.11		
1 1/4	5/8	1 1/2	9-2006-21	94.8	355	0.37	425	0.45	532	0.56	569	0.60
		1 3/4	9-2007-21	77.9	337	0.43	405	0.52	506	0.65	550	0.71
		2	9-2008-21	66.3	333	0.50	399	0.60	499	0.75	539	0.81
		2 1/2	9-2010-21	50.1	316	0.63	379	0.76	473	0.94	503	1.00
		3	9-2012-21	40.5	303	0.75	364	0.90	454	1.12	490	1.21
		3 1/2	9-2014-21	34.2	300	0.88	360	1.05	449	1.31	486	1.42
		4	9-2016-21	29.6	297	1.00	357	1.20	446	1.51	484	1.63
		4 1/2	9-2018-21	26.3	298	1.13	357	1.36	447	1.70	491	1.87
		5	9-2020-21	23.7	296	1.25	356	1.50	444	1.88	498	2.10
		5 1/2	9-2022-21	21.4	293	1.37	351	1.64	439	2.05	495	2.31
		6	9-2024-21	19.5	292	1.50	350	1.80	438	2.24	493	2.53
		7	9-2028-21	16.6	291	1.75	349	2.10	436	2.63	489	2.95
8	9-2032-21	14.4	288	2.00	345	2.40	432	3.00	486	3.38		
10	9-2040-21	11.4	285	2.50	342	3.00	428	3.75	483	4.23		
12	9-2048-21	9.5	285	3.00	342	3.60	428	4.50	484	5.10		
1 1/2	3/4	2	9-2408-21	97.4	489	0.50	587	0.60	733	0.75	762	0.78
		2 1/2	9-2410-21	73.5	463	0.63	556	0.76	694	0.94	722	0.98
		3	9-2412-21	60.1	450	0.75	539	0.90	674	1.12	725	1.21
		3 1/2	9-2414-21	50.1	439	0.88	527	1.05	658	1.31	704	1.40
		4	9-2416-21	43.4	436	1.00	523	1.20	654	1.51	707	1.63
		4 1/2	9-2418-21	37.9	429	1.13	515	1.36	643	1.70	693	1.83
		5	9-2420-21	34.0	425	1.25	510	1.50	638	1.88	698	2.05
		5 1/2	9-2422-21	30.6	419	1.37	502	1.64	628	2.05	687	2.25
		6	9-2424-21	27.9	417	1.50	501	1.80	626	2.24	691	2.47
		7	9-2428-21	23.7	415	1.75	498	2.10	623	2.63	687	2.89
		8	9-2432-21	20.6	412	2.00	494	2.40	617	3.00	683	3.32
		10	9-2440-21	16.5	413	2.50	495	3.00	619	3.75	693	4.21
12	9-2448-21	13.6	408	3.00	490	3.60	612	4.50	682	5.03		
2	1	2 1/2	9-3210-21	121.0	762	0.63	915	0.76	1143	0.94	1193	0.99
		3	9-3212-21	95.6	715	0.75	858	0.90	1073	1.12	1130	1.18
		3 1/2	9-3214-21	79.8	699	0.88	839	1.05	1049	1.31	1109	1.39
		4	9-3216-21	69.6	699	1.00	838	1.20	1048	1.51	1131	1.63
		4 1/2	9-3218-21	61.2	693	1.13	831	1.36	1039	1.70	1134	1.85
		5	9-3220-21	54.0	675	1.25	810	1.50	1013	1.88	1105	2.05
		5 1/2	9-3222-21	48.8	668	1.37	801	1.64	1001	2.05	1110	2.27
		6	9-3224-21	44.5	666	1.50	799	1.80	999	2.24	1112	2.50
		7	9-3228-21	37.9	664	1.75	797	2.10	996	2.63	1117	2.94
		8	9-3232-21	32.8	655	2.00	786	2.40	983	3.00	1103	3.36
		9	9-3236-21	29.1	656	2.25	787	2.70	984	3.38	1108	3.81
		10	9-3240-21	26.1	653	2.50	783	3.00	979	3.75	1111	4.26
12	9-3248-21	21.5	645	3.00	775	3.60	968	4.50	1105	5.13		
2 1/2	1 1/2	3	9-4012-21	174.0	1304	0.75	1565	0.90	1956	1.12	2113	1.22
		3 1/2	9-4014-21	143.0	1249	0.88	1499	1.05	1874	1.31	2056	1.44
		4	9-4016-21	121.0	1211	1.00	1453	1.20	1816	1.51	2016	1.66
		4 1/2	9-4018-21	106.0	1195	1.13	1434	1.36	1793	1.70	2031	1.91
		5	9-4020-21	93.7	1172	1.25	1406	1.50	1758	1.88	2003	2.14
		6	9-4024-21	75.9	1139	1.50	1366	1.80	1708	2.24	1963	2.59
		7	9-4028-21	63.8	1116	1.75	1339	2.10	1674	2.63	1935	3.04
		8	9-4032-21	55.0	1099	2.00	1319	2.40	1649	3.00	1916	3.48
		9	9-4036-21	48.8	1099	2.25	1318	2.70	1648	3.38	1944	3.98
		10	9-4040-21	43.9	1097	2.50	1316	3.00	1646	3.75	1964	4.48
		12	9-4048-21	36.2	1087	3.00	1305	3.60	1631	4.50	1966	5.42

DieMax XL™ Heavy Load Springs

Product Features:

- ◆ ISO color - Red
- ◆ High tensile strength chrome silicon material
- ◆ Optimal rectangular wire design
- ◆ Long life design for increased spring run-time

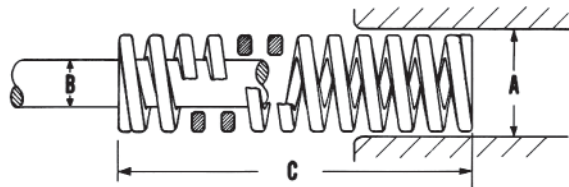

Hole Diam. (in) A	Rod Diam. (in) B	Free Length (in) C	CATALOG NUMBER	RATE Pounds Req'd. to deflect 1/10 in.	LOAD-DEFLECTION TABLE							
					Total Deflection Recommended for Long Life (20% of C)		Total Deflection Recommended for Avg. Life (25% of C)		Maximum Operating Deflection (30% of C)		Total Travel to Solid	
					Load lbs.	Defl. in.	Load lbs.	Defl. in.	Load lbs.	Defl. in.	Load lbs.	Defl. in.
3/8	3/16	3/4	9-0603-26	16.5	25	0.15	31	0.19	37	0.23	41	0.25
		1	9-0604-26	12.6	25	0.20	31	0.25	37	0.30	46	0.37
		1 1/4	9-0605-26	10.0	25	0.25	31	0.31	38	0.38	47	0.47
		1 1/2	9-0606-26	9.3	28	0.30	35	0.37	42	0.45	61	0.66
		1 3/4	9-0607-26	8.0	28	0.35	35	0.43	42	0.52	62	0.78
		2	9-0608-26	6.8	27	0.40	34	0.50	41	0.60	60	0.88
		2 1/2	9-0610-26	5.5	28	0.50	35	0.63	42	0.76	62	1.13
		3	9-0612-26	4.3	26	0.60	32	0.75	39	0.90	56	1.29
		12	9-0648-26	1.1	26	2.40	32	3.00	39	3.60	56	5.27
		1/2	9/32	3/4	9-0803-26	31.0	47	0.15	58	0.19	70	0.23
1	9-0804-26			23.6	46	0.20	58	0.25	70	0.30	103	0.44
1 1/4	9-0805-26			18.8	47	0.25	59	0.31	71	0.38	106	0.56
1 1/2	9-0806-26			15.5	46	0.30	58	0.37	70	0.45	107	0.69
1 3/4	9-0807-26			13.3	46	0.35	58	0.43	69	0.52	109	0.82
2	9-0808-26			11.4	46	0.40	57	0.50	69	0.60	107	0.94
2 1/2	9-0810-26			8.7	44	0.50	55	0.63	66	0.76	99	1.14
3	9-0812-26			7.7	46	0.60	58	0.75	69	0.90	114	1.47
3 1/2	9-0814-26			6.2	43	0.70	54	0.88	65	1.05	102	1.64
12	9-0848-26			1.8	43	2.40	53	3.00	64	3.60	101	5.71
5/8	11/32	3/4	9-1003-26	57.0	86	0.15	107	0.19	128	0.23	154	0.27
		1	9-1004-26	43.1	85	0.20	106	0.25	127	0.30	160	0.37
		1 1/4	9-1005-26	34.8	88	0.25	110	0.31	132	0.38	174	0.50
		1 1/2	9-1006-26	27.8	83	0.30	104	0.37	125	0.45	167	0.60
		1 3/4	9-1007-26	24.7	86	0.35	107	0.43	128	0.52	185	0.75
		2	9-1008-26	20.5	82	0.40	103	0.50	123	0.60	170	0.83
		2 1/2	9-1010-26	16.5	83	0.50	104	0.63	125	0.76	177	1.07
		3	9-1012-26	14.0	84	0.60	105	0.75	126	0.90	187	1.33
		3 1/2	9-1014-26	11.9	83	0.70	104	0.88	125	1.05	187	1.57
		4	9-1016-26	10.4	84	0.80	104	1.00	125	1.20	187	1.80
12	9-1048-26	3.3	80	2.40	100	3.00	120	3.60	181	5.44		
3/4	3/8	1	9-1204-26	137.0	270	0.20	337	0.25	405	0.30	422	0.31
		1 1/4	9-1205-26	103.0	260	0.25	324	0.31	389	0.38	407	0.40
		1 1/2	9-1206-26	82.2	246	0.30	307	0.37	369	0.45	398	0.48
		1 3/4	9-1207-26	68.5	237	0.35	297	0.43	356	0.52	392	0.57
		2	9-1208-26	57.8	232	0.40	290	0.50	348	0.60	371	0.64
		2 1/2	9-1210-26	44.0	222	0.50	277	0.63	333	0.76	344	0.78
		3	9-1212-26	36.2	217	0.60	271	0.75	325	0.90	347	0.96
		3 1/2	9-1214-26	30.8	216	0.70	270	0.88	324	1.05	350	1.13
		4	9-1216-26	26.8	215	0.80	269	1.00	323	1.20	351	1.31
		4 1/2	9-1218-26	23.7	213	0.90	266	1.12	319	1.35	352	1.49
		5	9-1220-26	21.2	212	1.00	265	1.25	318	1.50	353	1.66
		5 1/2	9-1222-26	19.3	213	1.10	266	1.38	319	1.65	354	1.84
		6	9-1224-26	17.6	211	1.20	263	1.50	316	1.80	355	2.01
12	9-1248-26	8.6	207	2.40	258	3.00	310	3.60	351	4.07		

Inch Standard

Hole Diam. (in) A	Rod Diam. (in) B	Free Length (in) C	CATALOG NUMBER	RATE Pounds Req'd. to deflect 1/10 in.	LOAD-DEFLECTION TABLE							
					Total Deflection Recommended for Long Life (20% of C)		Total Deflection Recommended for Avg. Life (25% of C)		Maximum Operating Deflection (30% of C)		Total Travel to Solid	
					Load lbs.	Defl. in.	Load lbs.	Defl. in.	Load lbs.	Defl. in.	Load lbs.	Defl. in.
1	1/2	1	9-1604-26	215.0	423	0.20	529	0.25	635	0.30	622	0.29
		1 1/4	9-1605-26	163.0	411	0.25	513	0.31	616	0.38	648	0.40
		1 1/2	9-1606-26	127.0	380	0.30	475	0.37	570	0.45	602	0.47
		1 3/4	9-1607-26	109.0	378	0.35	472	0.43	566	0.52	646	0.60
		2	9-1608-26	89.4	359	0.40	449	0.50	539	0.60	581	0.65
		2 1/2	9-1610-26	69.1	348	0.50	435	0.63	522	0.76	571	0.83
		3	9-1612-26	57.0	341	0.60	426	0.75	512	0.90	584	1.02
		3 1/2	9-1614-26	48.0	336	0.70	420	0.88	505	1.05	575	1.20
		4	9-1616-26	41.8	336	0.80	420	1.00	504	1.20	584	1.40
		4 1/2	9-1618-26	37.1	333	0.90	416	1.12	500	1.35	591	1.59
		5	9-1620-26	33.1	331	1.00	414	1.25	497	1.50	585	1.77
		5 1/2	9-1622-26	30.0	331	1.10	413	1.38	496	1.65	590	1.97
1 1/4	5/8	6	9-1624-26	27.5	329	1.20	411	1.50	494	1.80	595	2.16
		7	9-1628-26	23.5	329	1.40	412	1.75	494	2.10	602	2.56
		8	9-1632-26	20.5	328	1.60	410	2.00	492	2.40	599	2.93
		12	9-1648-26	13.8	331	2.40	414	3.00	497	3.60	638	4.62
		1 1/2	9-2006-26	223.0	667	0.30	834	0.37	1001	0.45	1021	0.46
		1 3/4	9-2007-26	182.0	631	0.35	788	0.43	946	0.52	995	0.55
		2	9-2008-26	154.0	618	0.40	773	0.50	928	0.60	976	0.63
		2 1/2	9-2010-26	117.0	590	0.50	737	0.63	884	0.76	926	0.79
		3	9-2012-26	94.7	567	0.60	708	0.75	850	0.90	916	0.97
		3 1/2	9-2014-26	80.1	561	0.70	702	0.88	842	1.05	926	1.16
		4	9-2016-26	69.1	555	0.80	694	1.00	832	1.20	919	1.33
		4 1/2	9-2018-26	60.7	545	0.90	681	1.12	817	1.35	914	1.50
1 1/2	3/4	5	9-2020-26	54.7	547	1.00	684	1.25	821	1.50	933	1.71
		5 1/2	9-2022-26	49.3	543	1.10	679	1.38	815	1.65	928	1.88
		6	9-2024-26	44.9	537	1.20	672	1.50	806	1.80	923	2.06
		7	9-2028-26	38.1	534	1.40	668	1.75	801	2.10	916	2.41
		8	9-2032-26	33.0	527	1.60	659	2.00	791	2.40	910	2.75
		10	9-2040-26	26.4	528	2.00	660	2.50	792	3.00	925	3.51
		12	9-2048-26	21.8	524	2.40	654	3.00	785	3.60	916	4.20
		2	9-2408-26	208.0	835	0.40	1044	0.50	1253	0.60	1357	0.65
		2 1/2	9-2410-26	153.0	771	0.50	964	0.63	1157	0.76	1233	0.80
		3	9-2412-26	125.0	748	0.60	935	0.75	1122	0.90	1252	1.00
		3 1/2	9-2414-26	105.0	736	0.70	920	0.88	1104	1.05	1265	1.20
		4	9-2416-26	90.6	728	0.80	910	1.00	1091	1.20	1252	1.38
4 1/2	9-2418-26	80.4	722	0.90	902	1.12	1083	1.35	1285	1.60		
5	9-2420-26	71.5	715	1.00	894	1.25	1073	1.50	1273	1.78		
5 1/2	9-2422-26	64.3	709	1.10	886	1.38	1063	1.65	1263	1.96		
6	9-2424-26	59.0	706	1.20	883	1.50	1059	1.80	1284	2.18		
7	9-2428-26	50.3	705	1.40	881	1.75	1057	2.10	1294	2.57		
8	9-2432-26	43.8	700	1.60	875	2.00	1050	2.40	1299	2.97		
10	9-2440-26	34.6	692	2.00	865	2.50	1038	3.00	1291	3.73		
12	9-2448-26	28.7	689	2.40	862	3.00	1034	3.60	1300	4.53		
2	1	2 1/2	9-3210-26	242.0	1220	0.50	1524	0.63	1829	0.76	1904	0.79
		3	9-3212-26	193.0	1155	0.60	1444	0.75	1732	0.90	1860	0.96
		3 1/2	9-3214-26	160.0	1121	0.70	1402	0.88	1682	1.05	1831	1.14
		4	9-3216-26	140.0	1124	0.80	1406	1.00	1687	1.20	1891	1.35
		4 1/2	9-3218-26	123.0	1104	0.90	1380	1.12	1656	1.35	1901	1.55
		5	9-3220-26	108.0	1080	1.00	1350	1.25	1620	1.50	1840	1.71
		5 1/2	9-3222-26	96.4	1063	1.10	1328	1.38	1594	1.65	1797	1.86
		6	9-3224-26	88.0	1053	1.20	1317	1.50	1580	1.80	1812	2.06
		7	9-3228-26	75.0	1051	1.40	1314	1.75	1577	2.10	1836	2.45
		8	9-3232-26	65.3	1044	1.60	1305	2.00	1566	2.40	1854	2.84
		10	9-3240-26	51.3	1026	2.00	1283	2.50	1539	3.00	1816	3.54
		12	9-3248-26	42.6	1023	2.40	1279	3.00	1535	3.60	1842	4.32
2 1/2	1 1/2	3	9-4012-26	295.0	1770	0.60	2213	0.75	2655	0.90	2980	1.01
		3.5	9-4014-26	241.0	1687	0.70	2109	0.88	2531	1.05	2952	1.23
		4	9-4016-26	205.0	1640	0.80	2050	1.00	2460	1.20	2952	1.44
		4.5	9-4018-26	178.0	1602	0.90	2003	1.13	2403	1.35	2964	1.67
		5	9-4020-26	157.0	1570	1.00	1963	1.25	2355	1.50	2944	1.88
		6	9-4024-26	128.0	1536	1.20	1920	1.50	2304	1.80	2880	2.25
		7	9-4028-26	108.0	1512	1.40	1890	1.75	2268	2.10	2835	2.63
		8	9-4032-26	93.0	1488	1.60	1860	2.00	2232	2.40	2790	3.00
		9	9-4036-26	82.0	1476	1.80	1845	2.25	2214	2.70	2768	3.38
		10	9-4040-26	73.5	1470	2.00	1838	2.50	2205	3.00	2756	3.75
		12	9-4048-26	61.0	1464	2.40	1830	3.00	2196	3.60	2745	4.50

DieMax XL™ Extra Heavy Load Springs

Product Features:

- ◆ ISO color - Yellow
- ◆ High tensile strength chrome silicon material
- ◆ Optimal rectangular wire design
- ◆ Long life design for increased spring run-time

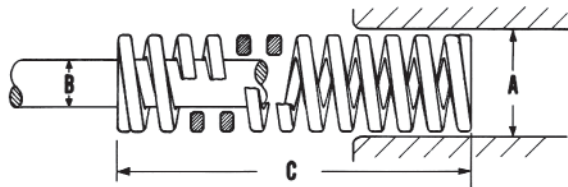

Hole Diam. (in) A	Rod Diam. (in) B	Free Length (in) C	CATALOG NUMBER	RATE Pounds Req'd. to deflect 1/10 in.	LOAD-DEFLECTION TABLE							
					Total Deflection Recommended for Long Life (17% of C)		Total Deflection Recommended for Avg. Life (20% of C)		Maximum Operating Deflection (25% of C)		Total Travel to Solid	
					Load lbs.	Defl. in.	Load lbs.	Defl. in.	Load lbs.	Defl. in.	Load lbs.	Defl. in.
3/8	3/16	3/4	9-0603-36	25.2	32	0.13	38	0.15	47	0.19	53	0.21
		1	9-0604-36	18.7	31	0.17	37	0.20	46	0.25	54	0.29
		1 1/4	9-0605-36	14.6	31	0.21	37	0.25	46	0.31	53	0.37
		1 1/2	9-0606-36	12.1	31	0.25	36	0.30	45	0.37	55	0.45
		1 3/4	9-0607-36	10.1	30	0.29	35	0.35	44	0.43	52	0.51
		2	9-0608-36	8.8	30	0.34	35	0.40	44	0.50	52	0.59
		2 1/2	9-0610-36	7.0	30	0.43	35	0.50	44	0.63	52	0.75
		3	9-0612-36	5.8	30	0.51	35	0.60	43	0.75	53	0.92
1/2	9/32	12	9-0648-36	1.4	29	2.04	34	2.40	42	3.00	52	3.71
		3/4	9-0803-36	44.5	57	0.13	67	0.15	83	0.19	102	0.23
		1	9-0804-36	33.5	56	0.17	66	0.20	82	0.25	105	0.31
		1 1/4	9-0805-36	25.2	54	0.21	63	0.25	79	0.31	97	0.38
		1 1/2	9-0806-36	20.7	53	0.25	62	0.30	77	0.37	97	0.47
		1 3/4	9-0807-36	17.5	52	0.29	61	0.35	76	0.43	98	0.56
		2	9-0808-36	15.4	53	0.34	62	0.40	77	0.50	103	0.67
		2 1/2	9-0810-36	12.4	53	0.43	62	0.50	78	0.63	109	0.88
		3	9-0812-36	10.1	51	0.51	60	0.60	76	0.75	106	1.04
		3 1/2	9-0814-36	8.6	51	0.60	60	0.70	75	0.88	105	1.22
5/8	11/32	12	9-0848-36	2.4	49	2.04	58	2.40	72	3.00	101	4.19
		3/4	9-1003-36	97.0	124	0.13	146	0.15	182	0.19	213	0.22
		1	9-1004-36	72.7	122	0.17	143	0.20	179	0.25	227	0.31
		1 1/4	9-1005-36	53.7	115	0.21	135	0.25	169	0.31	205	0.38
		1 1/2	9-1006-36	43.3	110	0.25	130	0.30	162	0.37	201	0.46
		1 3/4	9-1007-36	36.3	107	0.29	126	0.35	157	0.43	199	0.55
		2	9-1008-36	31.7	108	0.34	127	0.40	159	0.50	205	0.65
		2 1/2	9-1010-36	24.7	106	0.43	124	0.50	156	0.63	201	0.81
		3	9-1012-36	20.3	103	0.51	121	0.60	152	0.75	199	0.98
		3 1/2	9-1014-36	17.3	103	0.60	121	0.70	152	0.88	201	1.16
3/4	3/8	4	9-1016-36	15.1	103	0.68	121	0.80	152	1.00	203	1.35
		12	9-1048-36	4.9	100	2.04	117	2.40	146	3.00	204	4.17
		1	9-1204-36	183.0	306	0.17	360	0.20	450	0.25	469	0.26
		1 1/4	9-1205-36	137.0	293	0.21	345	0.25	431	0.31	461	0.34
		1 1/2	9-1206-36	111.0	282	0.25	332	0.30	415	0.37	472	0.43
		1 3/4	9-1207-36	92.4	272	0.29	320	0.35	400	0.43	466	0.50
		2	9-1208-36	79.7	272	0.34	320	0.40	400	0.50	473	0.59
		2 1/2	9-1210-36	62.1	266	0.43	313	0.50	391	0.63	472	0.76
		3	9-1212-36	51.2	260	0.51	306	0.60	383	0.75	481	0.94
		3 1/2	9-1214-36	43.2	257	0.60	303	0.70	378	0.88	474	1.10
		4	9-1216-36	37.3	255	0.68	300	0.80	374	1.00	468	1.25
		4 1/2	9-1218-36	32.8	250	0.76	294	0.90	368	1.12	464	1.41
		5	9-1220-36	29.5	251	0.85	295	1.00	369	1.25	469	1.59
		5 1/2	9-1222-36	26.6	249	0.94	293	1.10	367	1.38	466	1.75
6	9-1224-36	24.3	247	1.02	291	1.20	364	1.50	463	1.91		
12	9-1248-36	12.0	245	2.04	288	2.40	360	3.00	469	3.92		

Inch Standard

Hole Diam. (in) A	Rod Diam. (in) B	Free Length (in) C	CATALOG NUMBER	RATE Pounds Reqd. to deflect 1/10 in.	LOAD-DEFLECTION TABLE							
					Total Deflection Recommended for Long Life (17% of C)		Total Deflection Recommended for Avg. Life (20% of C)		Maximum Operating Deflection (25% of C)		Total Travel to Solid	
					Load lbs.	Defl. in.	Load lbs.	Defl. in.	Load lbs.	Defl. in.	Load lbs.	Defl. in.
1	1/2	1 1/4	9-1605-36	202.0	433	0.21	509	0.25	636	0.31	709	0.35
		1 1/2	9-1606-36	160.0	407	0.25	479	0.30	598	0.37	692	0.43
		1 3/4	9-1607-36	132.0	389	0.29	457	0.35	572	0.43	686	0.52
		2	9-1608-36	113.0	386	0.34	454	0.40	567	0.50	681	0.60
		2 1/2	9-1610-36	87.8	376	0.43	442	0.50	553	0.63	684	0.78
		3	9-1612-36	71.4	363	0.51	427	0.60	534	0.75	676	0.95
		3 1/2	9-1614-36	60.2	359	0.60	422	0.70	527	0.88	671	1.11
		4	9-1616-36	52.0	355	0.68	418	0.80	522	1.00	667	1.28
		4 1/2	9-1618-36	46.2	353	0.76	415	0.90	518	1.12	681	1.47
		5	9-1620-36	41.2	350	0.85	412	1.00	515	1.25	677	1.64
		5 1/2	9-1622-36	37.5	351	0.94	413	1.10	516	1.38	686	1.83
		6	9-1624-36	34.4	351	1.02	413	1.20	516	1.50	695	2.02
7	9-1628-36	29.3	349	1.19	410	1.40	513	1.75	697	2.38		
8	9-1632-36	25.5	347	1.36	408	1.60	510	2.00	700	2.74		
12	9-1648-36	16.9	345	2.04	406	2.40	507	3.00	704	4.18		
1 1/4	5/8	1 1/2	9-2006-36	279.0	710	0.25	835	0.30	1044	0.37	1093	0.39
		1 3/4	9-2007-36	231.0	680	0.29	800	0.35	1000	0.43	1108	0.48
		2	9-2008-36	197.0	672	0.34	791	0.40	989	0.50	1119	0.57
		2 1/2	9-2010-36	152.0	651	0.43	766	0.50	957	0.63	1139	0.75
		3	9-2012-36	123.0	626	0.51	736	0.60	920	0.75	1121	0.91
		3 1/2	9-2014-36	104.0	619	0.60	729	0.70	911	0.88	1131	1.09
		4	9-2016-36	88.9	607	0.68	714	0.80	893	1.00	1100	1.24
		4 1/2	9-2018-36	77.5	591	0.76	696	0.90	870	1.12	1071	1.38
		5	9-2020-36	69.6	592	0.85	696	1.00	870	1.25	1090	1.57
		5 1/2	9-2022-36	63.6	596	0.94	701	1.10	876	1.38	1128	1.77
		6	9-2024-36	57.6	586	1.02	689	1.20	862	1.50	1108	1.92
		7	9-2028-36	48.9	583	1.19	685	1.40	857	1.75	1099	2.25
8	9-2032-36	42.6	579	1.36	681	1.60	851	2.00	1111	2.61		
10	9-2040-36	34.0	578	1.70	680	2.00	850	2.50	1128	3.32		
12	9-2048-36	28.3	578	2.04	680	2.40	850	3.00	1139	4.03		
1 1/2	3/4	2	9-2408-36	319.0	1089	0.34	1281	0.40	1601	0.50	1757	0.55
		2 1/2	9-2410-36	241.0	1032	0.43	1214	0.50	1518	0.63	1726	0.72
		3	9-2412-36	193.0	982	0.51	1155	0.60	1444	0.75	1698	0.88
		3 1/2	9-2414-36	160.0	953	0.60	1121	0.70	1402	0.88	1636	1.03
		4	9-2416-36	139.0	949	0.68	1116	0.80	1395	1.00	1710	1.23
		4 1/2	9-2418-36	122.0	931	0.76	1095	0.90	1369	1.12	1700	1.39
		5	9-2420-36	108.0	918	0.85	1080	1.00	1350	1.25	1687	1.56
		5 1/2	9-2422-36	97.6	915	0.94	1076	1.10	1345	1.38	1681	1.72
		6	9-2424-36	88.7	902	1.02	1062	1.20	1327	1.50	1672	1.89
		7	9-2428-36	75.0	894	1.19	1051	1.40	1314	1.75	1662	2.22
		8	9-2432-36	65.0	883	1.36	1039	1.60	1299	2.00	1655	2.55
		10	9-2440-36	51.6	877	1.70	1032	2.00	1290	2.50	1675	3.24
12	9-2448-36	42.8	874	2.04	1028	2.40	1285	3.00	1686	3.94		
2	1	2 1/2	9-3210-36	414.0	1773	0.43	2086	0.50	2608	0.63	2818	0.68
		3	9-3212-36	327.0	1663	0.51	1957	0.60	2446	0.75	2743	0.84
		3 1/2	9-3214-36	271.0	1614	0.60	1899	0.70	2374	0.88	2694	1.00
		4	9-3216-36	231.0	1577	0.68	1855	0.80	2319	1.00	2659	1.15
		4 1/2	9-3218-36	201.0	1534	0.76	1804	0.90	2255	1.12	2644	1.31
		5	9-3220-36	179.0	1522	0.85	1790	1.00	2238	1.25	2623	1.47
		5 1/2	9-3222-36	161.0	1509	0.94	1775	1.10	2219	1.38	2659	1.65
		6	9-3224-36	145.0	1475	1.02	1735	1.20	2169	1.50	2593	1.78
		7	9-3228-36	123.0	1465	1.19	1724	1.40	2155	1.75	2578	2.10
		8	9-3232-36	106.0	1440	1.36	1694	1.60	2118	2.00	2562	2.41
		10	9-3240-36	83.5	1420	1.70	1670	2.00	2088	2.50	2544	3.05
		12	9-3248-36	68.9	1406	2.04	1655	2.40	2068	3.00	2533	3.68

DieMax XL™ Light Load Springs

Product Features:

- ◆ ISO color - Green
- ◆ High tensile strength chrome silicon material
- ◆ Optimal rectangular wire design
- ◆ Long life design for increased spring run-time

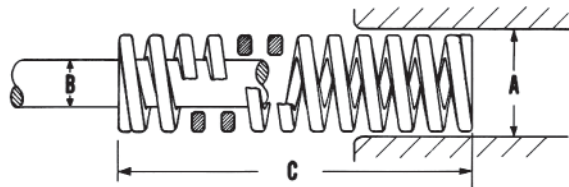

*Note: 1 Newton=0.10197 Kg (Force)

Hole Diam. (mm) A	Rod Diam. (mm) B	Free Length (mm) C	CATALOG NUMBER	RATE Newtons Reqd. to deflect 1 mm	LOAD-DEFLECTION TABLE							
					Total Deflection Recommended for Long Life (25% of C)		Total Deflection Recommended for Avg. Life (30% of C)		Maximum Operating Deflection (40% of C)		Total Travel to Solid	
					Load N	Defl. mm	Load N	Defl. mm	Load N	Defl. mm	Load N	Defl. mm
10	5	19	9-0603-11	14.7	70	4.75	84	5.70	112	7.60	142	9.7
		25	9-0604-11	11.0	69	6.3	83	7.5	110	10.0	157	13.2
		32	9-0605-11	8.8	70	8.0	84	9.6	112	12.8	162	17.0
		38	9-0606-11	7.4	70	9.5	84	11.4	112	15.2	164	20.3
		44	9-0607-11	6.3	69	11.0	83	13.2	111	17.6	164	24.4
		51	9-0608-11	5.4	68	12.8	82	15.3	109	20.4	158	27.4
		64	9-0610-11	4.5	72	16.0	86	19.2	115	25.6	170	36.8
		76	9-0612-11	3.7	71	19.0	85	22.8	113	30.4	172	43.2
12.5	7	305	9-0648-11	0.9	65	76.3	79	91.5	105	122.0	152	174.0
		19	9-0803-11	25.4	121	4.75	145	5.70	193	7.60	254	10.0
		25	9-0804-11	19.1	119	6.3	143	7.5	191	10.0	258	13.6
		32	9-0805-11	16.5	132	8.0	158	9.6	211	12.8	303	18.3
		38	9-0806-11	13.7	130	9.5	156	11.4	208	15.2	303	22.0
		44	9-0807-11	11.6	127	11.0	153	13.2	203	17.6	304	26.0
		51	9-0808-11	10.2	130	12.8	155	15.3	207	20.4	307	30.0
		64	9-0810-11	8.2	131	16.0	157	19.2	209	25.6	312	38.0
16	8.5	76	9-0812-11	6.2	118	19.0	142	22.8	190	30.4	276	44.0
		89	9-0814-11	5.3	119	22.3	143	26.7	190	35.6	276	52.0
		305	9-0848-11	1.5	112	76.3	135	91.5	179	122.0	257	175.0
		19	9-1003-11	38.5	183	4.75	219	5.70	293	7.60	350	9.1
		25	9-1004-11	31.5	197	6.3	236	7.5	315	10.0	422	13.3
		32	9-1005-11	23.5	188	8.0	225	9.6	300	12.8	385	16.4
		38	9-1006-11	21.0	200	9.5	240	11.4	319	15.2	443	21.0
		44	9-1007-11	17.5	193	11.0	231	13.2	308	17.6	432	25.0
20	10	51	9-1008-11	16.3	208	12.8	249	15.3	332	20.4	477	29.0
		64	9-1010-11	12.6	202	16.0	242	19.2	323	25.6	459	37.0
		76	9-1012-11	10.3	196	19.0	236	22.8	314	30.4	456	44.0
		89	9-1014-11	9.3	207	22.3	248	26.7	330	35.6	497	53.0
		102	9-1016-11	8.2	210	25.5	252	30.6	336	40.8	506	61.0
		305	9-1048-11	2.6	200	76.3	240	91.5	320	122.0	484	184.0
		19	9-1203-11	74.4	353	4.75	424	5.70	565	7.60	677	9.1
		25	9-1204-11	56.0	350	6.3	420	7.5	560	10.0	703	12.6
20	10	32	9-1205-11	42.7	342	8.0	410	9.6	547	12.8	678	15.9
		38	9-1206-11	33.8	321	9.5	385	11.4	514	15.2	640	18.9
		44	9-1207-11	28.4	312	11.0	375	13.2	499	17.6	632	22.0
		51	9-1208-11	24.9	317	12.8	380	15.3	507	20.4	641	26.0
		64	9-1210-11	19.3	308	16.0	370	19.2	493	25.6	619	32.0
		76	9-1212-11	16.1	306	19.0	367	22.8	490	30.4	633	39.0
		89	9-1214-11	13.5	300	22.3	360	26.7	480	35.6	610	45.0
		102	9-1216-11	11.9	304	25.5	364	30.6	486	40.8	622	53.0
		114	9-1218-11	10.5	299	28.5	359	34.2	479	45.6	624	59.0
		127	9-1220-11	9.3	295	31.8	354	38.1	472	50.8	609	66.0
		140	9-1222-11	8.5	297	35.0	357	42.0	476	56.0	618	73.0
		152	9-1224-11	7.9	299	38.0	359	45.6	479	60.8	634	80.0
		305	9-1248-11	3.8	288	76.3	346	91.5	462	122.0	601	159.0

ISO Standard Metric

Hole Diam. (mm) A	Rod Diam. (mm) B	Free Length (mm) C	CATALOG NUMBER	RATE Newtons Req'd. to deflect 1 mm	LOAD-DEFLECTION TABLE									
					Total Deflection Recommended for Long Life (25% of C)		Total Deflection Recommended for Avg. Life (30% of C)		Maximum Operating Deflection (40% of C)		Total Travel to Solid			
					Load N	Defl. mm	Load N	Defl. mm	Load N	Defl. mm	Load N	Defl. mm		
25	12.5	25	9-1604-11	107.2	670	6.3	804	7.5	1072	10.0	1315	12.3		
		32	9-1605-11	80.9	647	8.0	777	9.6	1036	12.8	1265	15.6		
		38	9-1606-11	64.8	616	9.5	739	11.4	985	15.2	1230	19.0		
		44	9-1607-11	53.6	589	11.0	707	13.2	943	17.6	1190	22.0		
		51	9-1608-11	46.4	592	12.8	710	15.3	947	20.4	1196	26.0		
		64	9-1610-11	35.7	572	16.0	686	19.2	915	25.6	1148	32.0		
		76	9-1612-11	29.4	559	19.0	671	22.8	894	30.4	1139	38.1		
		89	9-1614-11	24.7	549	22.3	659	26.7	879	35.6	1115	44.5		
		102	9-1616-11	21.2	540	25.5	648	30.6	865	40.8	1098	51.0		
		114	9-1618-11	18.7	534	28.5	641	34.2	855	45.6	1085	57.2		
		127	9-1620-11	16.8	534	31.8	641	38.1	854	50.8	1087	64.0		
		140	9-1622-11	15.2	533	35.0	640	42.0	853	56.0	1100	71.1		
		152	9-1624-11	14.0	532	38.0	639	45.6	852	60.8	1111	79.0		
		178	9-1628-11	12.1	538	44.5	645	53.4	860	71.2	1119	92.2		
		203	9-1632-11	10.5	533	50.8	640	60.9	853	81.2	1125	106.0		
305	9-1648-11	7.0	534	76.3	641	91.5	855	122.0	1129	158.0				
32	16	38	9-2006-11	101.4	963	9.5	1156	11.4	1541	15.2	1838	18.1		
		44	9-2007-11	83.2	915	11.0	1098	13.2	1464	17.6	1765	21.0		
		51	9-2008-11	71.3	909	12.8	1091	15.3	1454	20.4	1746	25.0		
		64	9-2010-11	55.0	880	16.0	1056	19.2	1408	25.6	1700	31.0		
		76	9-2012-11	46.1	875	19.0	1050	22.8	1400	30.4	1756	38.0		
		89	9-2014-11	38.9	865	22.3	1038	26.7	1384	35.6	1739	45.0		
		102	9-2016-11	33.6	857	25.5	1029	30.6	1372	40.8	1727	51.0		
		114	9-2018-11	29.6	844	28.5	1012	34.2	1350	45.6	1718	58.0		
		127	9-2020-11	26.3	834	31.8	1001	38.1	1335	50.8	1686	64.0		
		140	9-2022-11	23.6	827	35.0	993	42.0	1324	56.0	1661	70.0		
		152	9-2024-11	21.5	819	38.0	982	45.6	1310	60.8	1661	77.0		
		178	9-2028-11	18.2	811	44.5	973	53.4	1297	71.2	1642	90.0		
		203	9-2032-11	15.9	809	50.8	971	60.9	1294	81.2	1629	103.0		
		254	9-2040-11	12.6	801	63.5	961	76.2	1281	101.6	1599	128.0		
		305	9-2048-11	10.3	788	76.3	945	91.5	1261	122.0	1589	153.0		
40	20	51	9-2408-11	105.6	1346	12.8	1616	15.3	2154	20.4	2596	25.0		
		64	9-2410-11	80.2	1283	16.0	1540	19.2	2053	25.6	2481	31.0		
		76	9-2412-11	65.7	1248	19.0	1497	22.8	1996	30.4	2482	38.0		
		89	9-2414-11	55.7	1239	22.3	1487	26.7	1983	35.6	2488	45.0		
		102	9-2416-11	47.8	1219	25.5	1463	30.6	1951	40.8	2435	51.0		
		114	9-2418-11	42.2	1203	28.5	1443	34.2	1925	45.6	2441	58.0		
		127	9-2420-11	37.8	1201	31.8	1441	38.1	1922	50.8	2449	65.0		
		140	9-2422-11	34.0	1189	35.0	1427	42.0	1903	56.0	2415	71.0		
		152	9-2424-11	30.8	1171	38.0	1406	45.6	1874	60.8	2388	77.0		
		178	9-2428-11	26.3	1169	44.5	1403	53.4	1870	71.2	2374	91.0		
		203	9-2432-11	22.6	1147	50.8	1376	60.9	1834	81.2	2339	103.0		
		254	9-2440-11	18.0	1145	63.5	1375	76.2	1833	101.6	2331	130.0		
		305	9-2448-11	14.7	1122	76.3	1346	91.5	1795	122.0	2293	155.0		
		50	25	64	9-3210-11	157.4	2519	16.0	3023	19.2	4031	25.6	4874	31.0
				76	9-3212-11	126.1	2396	19.0	2875	22.8	3833	30.4	4733	38.0
89	9-3214-11			105.4	2346	22.3	2815	26.7	3753	35.6	4652	44.0		
102	9-3216-11			89.7	2287	25.5	2744	30.6	3658	40.8	4519	51.0		
114	9-3218-11			78.6	2241	28.5	2689	34.2	3586	45.6	4475	58.0		
127	9-3220-11			70.1	2224	31.8	2669	38.1	3559	50.8	4449	64.0		
140	9-3222-11			63.0	2207	35.0	2648	42.0	3531	56.0	4421	70.0		
152	9-3224-11			57.4	2183	38.0	2619	45.6	3493	60.8	4404	77.0		
178	9-3228-11			48.7	2167	44.5	2600	53.4	3466	71.2	4373	90.0		
203	9-3232-11			41.7	2115	50.8	2538	60.9	3385	81.2	4231	102.0		
254	9-3240-11			32.9	2091	63.5	2509	76.2	3345	101.6	4224	128.0		
305	9-3248-11			27.1	2070	76.3	2484	91.5	3312	122.0	4180	154.0		
63	38			76	9-4012-11	192.6	3660	19.0	4392	22.8	5856	30.4	6976	36.0
				89	9-4014-11	157.4	3503	22.3	4204	26.7	5605	35.6	6726	43.0
				102	9-4016-11	133.5	3403	25.5	4084	30.6	5445	40.8	6552	49.0
		114	9-4018-11	115.6	3294	28.5	3953	34.2	5271	45.6	6404	55.0		
		127	9-4020-11	103.0	3270	31.8	3923	38.1	5231	50.8	6412	62.0		
		152	9-4024-11	83.4	3168	38.0	3801	45.6	5068	60.8	6254	75.0		
		178	9-4028-11	70.1	3117	44.5	3741	53.4	4988	71.2	6136	88.0		
		203	9-4032-11	60.2	3057	50.8	3669	60.9	4892	81.2	6060	100.0		
		254	9-4040-11	46.8	2969	63.5	3563	76.2	4751	101.6	5851	125.0		
		305	9-4048-11	38.5	2938	76.3	3525	91.5	4701	122.0	5798	150.0		

DieMax XL™ Medium Load Springs

Product Features:

- ◆ ISO color - Blue
- ◆ High tensile strength chrome silicon material
- ◆ Optimal rectangular wire design
- ◆ Long life design for increased spring run-time

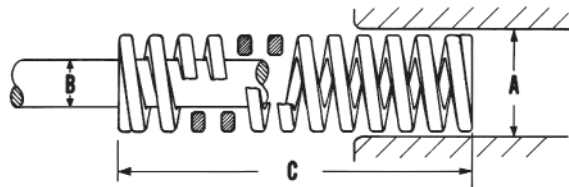

*Note: 1 Newton=0.10197 Kg (Force)

Hole Diam. (mm) A	Rod Diam. (mm) B	Free Length (mm) C	CATALOG NUMBER	RATE Newtons Req'd. to deflect 1 mm	LOAD-DEFLECTION TABLE							
					Total Deflection Recommended for Long Life (25% of C)		Total Deflection Recommended for Avg. Life (30% of C)		Maximum Operating Deflection (37.5% of C)		Total Travel to Solid	
					Load N	Defl. mm	Load N	Defl. mm	Load N	Defl. mm	Load N	Defl. mm
10	5	19	9-0603-21	21.9	104	4.75	125	5.70	156	7.13	175	8.0
		25	9-0604-21	16.3	102	6.3	122	7.5	153	9.4	188	11.6
		32	9-0605-21	14.0	112	8.0	135	9.6	168	12.0	224	15.9
		38	9-0606-21	11.7	111	9.5	134	11.4	167	14.3	228	19.4
		44	9-0607-21	9.8	108	11.0	129	13.2	162	16.5	224	23.0
		51	9-0608-21	8.6	110	12.8	132	15.3	165	19.1	224	26.0
		64	9-0610-21	6.8	108	16.0	130	19.2	163	24.0	221	33.0
		76	9-0612-21	5.7	108	19.0	130	22.8	162	28.5	226	40.0
		305	9-0648-21	1.3	101	76.3	122	91.5	152	114.4	205	154.0
12.5	7	19	9-0803-21	36.8	175	4.75	210	5.70	262	7.13	280	7.6
		25	9-0804-21	28.9	181	6.3	217	7.5	271	9.4	366	12.7
		32	9-0805-21	22.6	181	8.0	217	9.6	271	12.0	365	16.1
		38	9-0806-21	19.1	181	9.5	218	11.4	272	14.3	381	19.9
		44	9-0807-21	16.1	177	11.0	213	13.2	266	16.5	372	23.0
		51	9-0808-21	14.0	179	12.8	214	15.3	268	19.1	378	27.0
		64	9-0810-21	11.0	177	16.0	212	19.2	265	24.0	366	33.0
		76	9-0812-21	8.8	166	19.0	200	22.8	250	28.5	343	39.0
		89	9-0814-21	7.5	166	22.3	200	26.7	250	33.4	344	46.0
		305	9-0848-21	2.2	166	76.3	199	91.5	248	114.4	349	161.0
16	8.5	19	9-1003-21	67.4	320	4.75	384	5.70	480	7.13	546	8.1
		25	9-1004-21	55.7	348	6.3	418	7.5	522	9.4	629	11.3
		32	9-1005-21	40.3	322	8.0	387	9.6	483	12.0	547	13.6
		38	9-1006-21	35.2	334	9.5	401	11.4	502	14.3	621	17.6
		44	9-1007-21	30.5	335	11.0	402	13.2	503	16.5	646	21.0
		51	9-1008-21	27.0	344	12.8	413	15.3	516	19.1	670	25.0
		64	9-1010-21	21.0	336	16.0	404	19.2	504	24.0	651	31.0
		76	9-1012-21	17.7	336	19.0	403	22.8	504	28.5	682	38.0
		89	9-1014-21	15.2	339	22.3	407	26.7	509	33.4	690	45.0
		102	9-1016-21	13.3	339	25.5	407	30.6	509	38.3	685	52.0
		305	9-1048-21	4.1	315	76.3	378	91.5	473	114.4	630	153.0
20	10	19	9-1203-21	120.0	570	4.75	684	5.70	855	7.13	888	7.4
		25	9-1204-21	90.2	564	6.3	676	7.5	846	9.4	925	10.3
		32	9-1205-21	68.1	545	8.0	654	9.6	818	12.0	880	12.9
		38	9-1206-21	54.8	521	9.5	625	11.4	781	14.3	855	15.6
		44	9-1207-21	45.2	497	11.0	596	13.2	746	16.5	810	18.0
		51	9-1208-21	38.9	496	12.8	595	15.3	744	19.1	801	21.0
		64	9-1210-21	30.3	485	16.0	582	19.2	727	24.0	789	26.0
		76	9-1212-21	24.7	469	19.0	563	22.8	704	28.5	768	31.0
		89	9-1214-21	21.4	475	22.3	570	26.7	713	33.4	790	37.0
		102	9-1216-21	18.6	473	25.5	568	30.6	710	38.3	795	43.0
		115	9-1218-21	16.3	468	28.8	562	34.5	702	43.1	780	48.0
		127	9-1220-21	14.5	462	31.8	554	38.1	692	47.6	777	53.0
		139	9-1222-21	13.1	456	34.8	548	41.7	685	52.1	774	59.0
		152	9-1224-21	12.1	459	38.0	551	45.6	689	57.0	772	64.0
		305	9-1248-21	6.1	462	76.3	554	91.5	693	114.4	802	132.0

ISO Standard Metric

Hole Diam. (mm) A	Rod Diam. (mm) B	Free Length (mm) C	CATALOG NUMBER	RATE Newtons Reqd. to deflect 1 mm	LOAD-DEFLECTION TABLE							
					Total Deflection Recommended for Long Life (25% of C)		Total Deflection Recommended for Avg. Life (30% of C)		Maximum Operating Deflection (37.5% of C)		Total Travel to Solid	
					Load N	Defl. mm	Load N	Defl. mm	Load N	Defl. mm	Load N	Defl. mm
25	12.5	25	9-1604-21	166.2	1039	6.3	1246	7.5	1558	9.4	1649	9.9
		32	9-1605-21	124.7	998	8.0	1197	9.6	1496	12.0	1586	12.7
		38	9-1606-21	98.6	937	9.5	1124	11.4	1405	14.3	1505	15.3
		44	9-1607-21	83.2	915	11.0	1098	13.2	1373	16.5	1519	18.3
		51	9-1608-21	71.8	915	12.8	1099	15.3	1373	19.1	1528	21.0
		64	9-1610-21	55.0	880	16.0	1056	19.2	1320	24.0	1455	26.0
		76	9-1612-21	45.2	858	19.0	1030	22.8	1288	28.5	1445	32.0
		89	9-1614-21	37.8	842	22.3	1010	26.7	1263	33.4	1408	37.0
		102	9-1616-21	32.9	840	25.5	1007	30.6	1259	38.3	1405	43.0
		115	9-1618-21	29.2	841	28.8	1009	34.5	1261	43.1	1425	49.0
		127	9-1620-21	26.3	834	31.8	1001	38.1	1251	47.6	1422	54.0
		139	9-1622-21	23.6	822	34.8	986	41.7	1232	52.1	1419	60.0
		152	9-1624-21	21.7	825	38.0	990	45.6	1238	57.0	1417	65.0
		178	9-1628-21	18.4	818	44.5	982	53.4	1227	66.8	1399	76.0
203	9-1632-21	15.9	809	50.8	971	60.9	1213	76.1	1386	87.0		
305	9-1648-21	10.5	801	76.3	961	91.5	1202	114.4	1357	130.0		
32	16	38	9-2006-21	166.0	1577	9.5	1893	11.4	2366	14.3	2532	15.2
		44	9-2007-21	136.4	1501	11.0	1801	13.2	2251	16.5	2447	17.9
		51	9-2008-21	116.1	1480	12.8	1777	15.3	2221	19.1	2397	21.0
		64	9-2010-21	87.7	1404	16.0	1685	19.2	2106	24.0	2238	26.0
		76	9-2012-21	70.9	1348	19.0	1617	22.8	2021	28.5	2178	31.0
		89	9-2014-21	59.9	1333	22.3	1599	26.7	1999	33.4	2163	36.0
		102	9-2016-21	51.8	1322	25.5	1586	30.6	1983	38.3	2153	42.0
		115	9-2018-21	46.1	1324	28.8	1589	34.5	1986	43.1	2185	47.0
		127	9-2020-21	41.5	1318	31.8	1581	38.1	1977	47.6	2214	53.0
		139	9-2022-21	37.5	1302	34.8	1563	41.7	1954	52.1	2202	59.0
		152	9-2024-21	34.2	1298	38.0	1557	45.6	1947	57.0	2191	64.0
		178	9-2028-21	29.1	1294	44.5	1552	53.4	1941	66.8	2175	75.0
		203	9-2032-21	25.2	1280	50.8	1536	60.9	1920	76.1	2163	86.0
		254	9-2040-21	20.0	1268	63.5	1521	76.2	1902	95.3	2147	107.0
305	9-2048-21	16.6	1269	76.3	1522	91.5	1903	114.4	2151	130.0		
40	20	51	9-2408-21	170.6	2175	12.8	2610	15.3	3262	19.1	3390	19.9
		64	9-2410-21	128.7	2060	16.0	2471	19.2	3089	24.0	3210	25.0
		76	9-2412-21	105.3	2000	19.0	2400	22.8	3000	28.5	3224	31.0
		89	9-2414-21	87.7	1952	22.3	2343	26.7	2928	33.4	3129	36.0
		102	9-2416-21	76.0	1938	25.5	2326	30.6	2907	38.3	3143	41.0
		115	9-2418-21	66.4	1908	28.8	2290	34.5	2862	43.1	3081	46.0
		127	9-2420-21	59.5	1891	31.8	2269	38.1	2836	47.6	3102	52.0
		139	9-2422-21	53.6	1862	34.8	2235	41.7	2793	52.1	3057	57.0
		152	9-2424-21	48.9	1857	38.0	2228	45.6	2785	57.0	3072	63.0
		178	9-2428-21	41.5	1847	44.5	2216	53.4	2771	66.8	3054	74.0
		203	9-2432-21	36.1	1831	50.8	2197	60.9	2746	76.1	3038	84.0
		254	9-2440-21	28.9	1835	63.5	2202	76.2	2752	95.3	3083	107.0
		305	9-2448-21	23.8	1816	76.3	2179	91.5	2724	114.4	3033	128.0
		50	25	64	9-3210-21	211.9	3391	16.0	4069	19.2	5086	24.0
76	9-3212-21			167.4	3181	19.0	3817	22.8	4772	28.5	5024	30.0
89	9-3214-21			139.8	3110	22.3	3731	26.7	4664	33.4	4932	35.0
102	9-3216-21			121.9	3108	25.5	3730	30.6	4662	38.3	5042	41.0
115	9-3218-21			107.2	3081	28.8	3698	34.5	4622	43.1	5041	47.0
127	9-3220-21			94.6	3003	31.8	3603	38.1	4504	47.6	4914	52.0
139	9-3222-21			85.5	2970	34.8	3564	41.7	4455	52.1	4935	58.0
152	9-3224-21			77.9	2961	38.0	3554	45.6	4442	57.0	4945	63.0
178	9-3228-21			66.4	2954	44.5	3544	53.4	4431	66.8	4966	75.0
203	9-3232-21			57.4	2915	50.8	3498	60.9	4373	76.1	4905	85.0
229	9-3236-21			51.0	2918	57.3	3501	68.7	4376	85.9	4926	97.0
254	9-3240-21			45.7	2903	63.5	3483	76.2	4354	95.3	4943	108.0
305	9-3248-21			37.7	2871	76.3	3445	91.5	4307	114.4	4913	130.0
63	38			76	9-4012-21	304.7	5790	19.0	6948	22.8	8685	28.5
		89	9-4014-21	250.4	5572	22.3	6687	26.7	8358	33.4	9143	37.0
		102	9-4016-21	211.9	5404	25.5	6484	30.6	8106	38.3	8965	42.0
		115	9-4018-21	185.6	5337	28.8	6405	34.5	8006	43.1	9032	49.0
		127	9-4020-21	164.1	5210	31.8	6252	38.1	7815	47.6	8908	54.0
		152	9-4024-21	132.9	5051	38.0	6061	45.6	7577	57.0	8729	66.0
		178	9-4028-21	111.7	4972	44.5	5967	53.4	7458	66.8	8608	77.0
		203	9-4032-21	96.3	4888	50.8	5866	60.9	7333	76.1	8520	89.0
		229	9-4036-21	85.5	4893	57.3	5871	68.7	7339	85.9	8647	101.0
		254	9-4040-21	76.9	4882	63.5	5858	76.2	7323	95.3	8735	114.0
305	9-4048-21	63.4	4834	76.3	5801	91.5	7251	114.4	8742	138.0		

DieMax XL™ Heavy Load Springs

Product Features:

- ◆ ISO color - Red
- ◆ High tensile strength chrome silicon material
- ◆ Optimal rectangular wire design
- ◆ Long life design for increased spring run-time

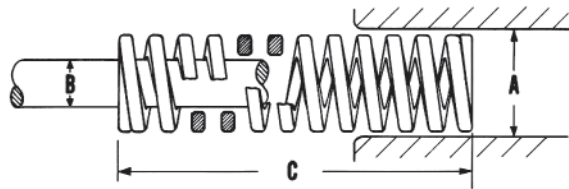

*Note: 1 Newton=0.10197 Kg (Force)

Hole Diam. (mm) A	Rod Diam. (mm) B	Free Length (mm) C	CATALOG NUMBER	RATE Newtons Reqd. to deflect 1 mm.	LOAD-DEFLECTION TABLE							
					Total Deflection Recommended for Long Life (20% of C)		Total Deflection Recommended for Avg. Life (25% of C)		Maximum Operating Deflection (30% of C)		Total Travel to Solid	
					Load N	Defl. mm	Load N	Defl. mm	Load N	Defl. mm	Load N	Defl. mm
10	5	19	9-0603-26	28.9	110	3.80	137	4.75	165	5.70	188	6.5
		25	9-0604-26	22.1	110	5.0	138	6.3	165	7.5	205	9.3
		32	9-0605-26	17.5	112	6.4	140	8.0	168	9.6	209	11.9
		38	9-0606-26	16.3	124	7.6	155	9.5	186	11.4	272	16.7
		44	9-0607-26	14.0	123	8.8	154	11.0	185	13.2	276	19.8
		51	9-0608-26	11.9	121	10.2	152	12.8	182	15.3	268	22.0
		64	9-0610-26	9.6	123	12.8	154	16.0	185	19.2	276	29.0
		76	9-0612-26	7.6	116	15.2	144	19.0	173	22.8	248	33.0
12.5	7	305	9-0648-26	1.9	114	61.0	143	76.3	171	91.5	250	134.0
		19	9-0803-26	54.3	206	3.80	258	4.75	310	5.70	429	7.9
		25	9-0804-26	41.3	207	5.0	258	6.3	310	7.5	457	11.1
		32	9-0805-26	32.9	211	6.4	263	8.0	316	9.6	472	14.3
		38	9-0806-26	27.1	206	7.6	258	9.5	309	11.4	477	17.6
		44	9-0807-26	23.3	205	8.8	256	11.0	307	13.2	485	21.0
		51	9-0808-26	20.0	204	10.2	255	12.8	305	15.3	476	24.0
		64	9-0810-26	15.2	195	12.8	244	16.0	293	19.2	441	29.0
16	8.5	76	9-0812-26	13.5	205	15.2	256	19.0	307	22.8	507	37.0
		89	9-0814-26	10.9	193	17.8	242	22.3	290	26.7	455	42.0
		305	9-0848-26	3.1	189	61.0	236	76.3	284	91.5	451	145.0
		19	9-1003-26	99.8	379	3.80	474	4.75	569	5.70	689	6.9
		25	9-1004-26	75.5	377	5.0	472	6.3	566	7.5	712	9.4
		32	9-1005-26	60.9	390	6.4	488	8.0	585	9.6	776	12.7
		38	9-1006-26	48.7	370	7.6	463	9.5	555	11.4	744	15.3
		44	9-1007-26	43.3	381	8.8	476	11.0	571	13.2	825	19.1
20	10	51	9-1008-26	35.9	366	10.2	458	12.8	549	15.3	758	21.0
		64	9-1010-26	28.9	370	12.8	462	16.0	555	19.2	787	27.0
		76	9-1012-26	24.5	373	15.2	466	19.0	559	22.8	830	34.0
		89	9-1014-26	20.8	371	17.8	464	22.3	556	26.7	833	40.0
		102	9-1016-26	18.2	372	20.4	464	25.5	557	30.6	833	46.0
		305	9-1048-26	5.8	356	61.0	445	76.3	534	91.5	806	138.0
		25	9-1204-26	239.9	1200	5.0	1500	6.3	1799	7.5	1879	7.8
		32	9-1205-26	180.4	1154	6.4	1443	8.0	1732	9.6	1811	10.1
20	10	38	9-1206-26	144.0	1094	7.6	1368	9.5	1641	11.4	1770	12.3
		44	9-1207-26	120.0	1056	8.8	1320	11.0	1584	13.2	1743	14.5
		51	9-1208-26	101.2	1033	10.2	1291	12.8	1549	15.3	1651	16.3
		64	9-1210-26	77.1	986	12.8	1233	16.0	1480	19.2	1532	19.9
		76	9-1212-26	63.4	964	15.2	1205	19.0	1445	22.8	1545	24.0
		89	9-1214-26	53.9	960	17.8	1200	22.3	1440	26.7	1554	29.0
		102	9-1216-26	46.9	957	20.4	1197	25.5	1436	30.6	1561	33.0
		114	9-1218-26	41.5	946	22.8	1183	28.5	1420	34.2	1567	38.0
		127	9-1220-26	37.1	943	25.4	1179	31.8	1415	38.1	1571	42.0
		140	9-1222-26	33.8	946	28.0	1183	35.0	1420	42.0	1574	47.0
		152	9-1224-26	30.8	937	30.4	1171	38.0	1406	45.6	1577	51.0
		305	9-1248-26	15.1	919	61.0	1148	76.3	1378	91.5	1560	103.0

ISO Standard Metric

Hole Diam. (mm) A	Rod Diam. (mm) B	Free Length (mm) C	CATALOG NUMBER	RATE Newtons Reqd. to deflect 1 mm	LOAD-DEFLECTION TABLE									
					Total Deflection Recommended for Long Life (20% of C)		Total Deflection Recommended for Avg. Life (25% of C)		Maximum Operating Deflection (30% of C)		Total Travel to Solid			
					Load N	Defl. mm	Load N	Defl. mm	Load N	Defl. mm	Load N	Defl. mm		
25	12.5	25	9-1604-26	376.5	1883	5.0	2353	6.3	2824	7.5	2782	7.4		
		32	9-1605-26	285.5	1827	6.4	2284	8.0	2740	9.6	2883	10.1		
		38	9-1606-26	222.4	1690	7.6	2113	9.5	2536	11.4	2676	12.1		
		44	9-1607-26	190.9	1680	8.8	2100	11.0	2520	13.2	2875	15.1		
		51	9-1608-26	156.6	1597	10.2	1996	12.8	2395	15.3	2583	16.5		
		64	9-1610-26	121.0	1549	12.8	1936	16.0	2324	19.2	2540	21.0		
		76	9-1612-26	99.8	1517	15.2	1897	19.0	2276	22.8	2596	26.0		
		89	9-1614-26	84.1	1496	17.8	1870	22.3	2244	26.7	2558	30.0		
		102	9-1616-26	73.2	1493	20.4	1867	25.5	2240	30.6	2597	35.0		
		114	9-1618-26	65.0	1481	22.8	1852	28.5	2222	34.2	2626	40.0		
		127	9-1620-26	58.0	1472	25.4	1840	31.8	2209	38.1	2601	45.0		
		140	9-1622-26	52.5	1471	28.0	1839	35.0	2207	42.0	2625	50.0		
		152	9-1624-26	48.2	1464	30.4	1830	38.0	2196	45.6	2645	55.0		
		178	9-1628-26	41.2	1465	35.6	1831	44.5	2198	53.4	2676	65.0		
203	9-1632-26	35.9	1458	40.6	1822	50.8	2186	60.9	2666	74.0				
305	9-1648-26	24.2	1474	61.0	1843	76.3	2211	91.5	2839	117.0				
32	16	38	9-2006-26	390.5	2968	7.6	3710	9.5	4452	11.4	4542	11.6		
		44	9-2007-26	318.7	2805	8.8	3506	11.0	4207	13.2	4424	13.9		
		51	9-2008-26	269.7	2751	10.2	3439	12.8	4126	15.3	4342	16.1		
		64	9-2010-26	204.9	2623	12.8	3278	16.0	3934	19.2	4119	20.0		
		76	9-2012-26	165.8	2521	15.2	3151	19.0	3781	22.8	4076	25.0		
		89	9-2014-26	140.3	2497	17.8	3121	22.3	3745	26.7	4119	29.0		
		102	9-2016-26	121.0	2469	20.4	3086	25.5	3703	30.6	4087	34.0		
		114	9-2018-26	106.3	2424	22.8	3030	28.5	3636	34.2	4063	38.0		
		127	9-2020-26	95.8	2433	25.4	3042	31.8	3650	38.1	4151	43.0		
		140	9-2022-26	86.3	2418	28.0	3022	35.0	3626	42.0	4126	48.0		
		152	9-2024-26	78.6	2390	30.4	2988	38.0	3586	45.6	4104	52.0		
		178	9-2028-26	66.7	2375	35.6	2969	44.5	3563	53.4	4072	61.0		
		203	9-2032-26	57.8	2346	40.6	2933	50.8	3520	60.9	4048	70.0		
		254	9-2040-26	46.2	2349	50.8	2936	63.5	3523	76.2	4114	89.0		
305	9-2048-26	38.2	2329	61.0	2911	76.3	3493	91.5	4075	107.0				
40	20	51	9-2408-26	364.3	3716	10.2	4644	12.8	5573	15.3	6037	16.6		
		64	9-2410-26	268.0	3430	12.8	4287	16.0	5145	19.2	5483	230.0		
		76	9-2412-26	218.9	3327	15.2	4159	19.0	4991	22.8	5568	25.0		
		89	9-2414-26	183.9	3273	17.8	4092	22.3	4910	26.7	5627	30.0		
		102	9-2416-26	158.7	3237	20.4	4046	25.5	4855	30.6	5570	35.0		
		114	9-2418-26	140.8	3210	22.8	4013	28.5	4816	34.2	5717	41.0		
		127	9-2420-26	125.2	3181	25.4	3976	31.8	4771	38.1	5662	45.0		
		140	9-2422-26	112.6	3153	28.0	3941	35.0	4730	42.0	5618	50.0		
		152	9-2424-26	103.3	3141	30.4	3926	38.0	4712	45.6	5711	55.0		
		178	9-2428-26	88.1	3136	35.6	3920	44.5	4704	53.4	5755	65.0		
		203	9-2432-26	76.7	3114	40.6	3893	50.8	4671	60.9	5779	75.0		
		254	9-2440-26	60.6	3078	50.8	3848	63.5	4617	76.2	5742	95.0		
		305	9-2448-26	50.3	3066	61.0	3833	76.3	4599	91.5	5782	115.0		
		50	25	64	9-3210-26	423.8	5425	12.8	6781	16.0	8137	19.2	8467	20.0
76	9-3212-26			338.0	5138	15.2	6422	19.0	7706	22.8	8273	25.0		
89	9-3214-26			280.2	4988	17.8	6235	22.3	7482	26.7	8144	29.0		
102	9-3216-26			245.2	5002	20.4	6252	25.5	7503	30.6	8412	34.0		
114	9-3218-26			215.4	4911	22.8	6139	28.5	7367	34.2	8457	39.0		
127	9-3220-26			189.1	4804	25.4	6005	31.8	7206	38.1	8184	43.0		
140	9-3222-26			168.8	4727	28.0	5909	35.0	7091	42.0	7990	47.0		
152	9-3224-26			154.1	4685	30.4	5856	38.0	7028	45.6	8059	52.0		
178	9-3228-26			131.3	4676	35.6	5845	44.5	7014	53.4	8165	62.0		
203	9-3232-26			114.4	4643	40.6	5804	50.8	6965	60.9	8245	72.0		
254	9-3240-26			89.8	4564	50.8	5705	63.5	6846	76.2	8075	90.0		
305	9-3248-26			74.6	4551	61.0	5689	76.3	6826	91.5	8193	110.0		
63	38			76	9-4012-26	516.6	398	15.2	9841	19.0	11809	22.8	13253	25.7
				89	9-4014-26	422.1	379	17.8	9380	22.3	11256	26.7	13134	31.1
		102	9-4016-26	359.0	369	20.4	9118	25.5	10942	30.6	13131	36.6		
		114	9-4018-26	311.7	360	22.8	8907	28.5	10689	34.2	13182	42.3		
		127	9-4020-26	274.9	353	25.4	8729	31.8	10475	38.1	13092	47.6		
		152	9-4024-26	224.1	345	30.4	8540	38.0	10248	45.6	12807	57.2		
		178	9-4028-26	189.1	340	35.6	8407	44.5	10088	53.4	12608	66.7		
		203	9-4032-26	162.9	335	40.6	8273	50.8	9928	60.9	12413	76.2		
		229	9-4036-26	143.6	332	45.8	8207	57.3	9848	68.7	12310	85.7		
		254	9-4040-26	128.7	330	50.8	8173	63.5	9808	76.2	12259	95.3		
305	9-4048-26	106.8	329	61.0	8140	76.3	9768	91.5	12207	114.3				

DieMax XL™ Extra Heavy Load Springs

Product Features:

- ◆ ISO color - Yellow
- ◆ High tensile strength chrome silicon material
- ◆ Optimal rectangular wire design
- ◆ Long life design for increased spring run-time

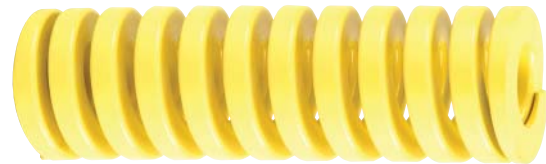
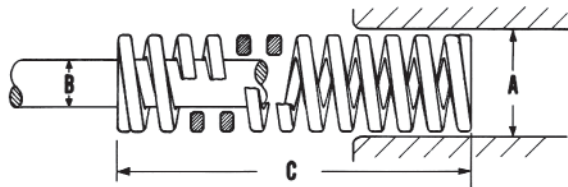

*Note: 1 Newton=0.10197 Kg (Force)

Hole Diam. (mm) A	Rod Diam. (mm) B	Free Length (mm) C	CATALOG NUMBER	RATE Newtons Req'd. to deflect 1 mm	LOAD-DEFLECTION TABLE							
					Total Deflection Recommended for Long Life (17% of C)		Total Deflection Recommended for Avg. Life (20% of C)		Maximum Operating Deflection (25% of C)		Total Travel to Solid	
					Load N	Defl. mm	Load N	Defl. mm	Load N	Defl. mm	Load N	Defl. mm
10	5	19	9-0603-36	44.1	142	3.23	168	3.80	209	4.75	234	5.30
		25	9-0604-36	32.7	139	4.3	164	5.0	205	6.3	241	7.3
		32	9-0605-36	25.6	139	5.4	164	6.4	205	8.0	238	9.3
		38	9-0606-36	21.2	137	6.5	161	7.6	201	9.5	243	11.5
		44	9-0607-36	17.7	132	7.5	156	8.8	195	11.0	230	13.0
		51	9-0608-36	15.4	134	8.7	157	10.2	196	12.8	230	15.0
		64	9-0610-36	12.3	133	10.9	157	12.8	196	16.0	233	19.1
		76	9-0612-36	10.2	131	12.9	154	15.2	193	19.0	236	23.0
12.5	7	305	9-0648-36	2.5	127	51.9	150	61.0	187	76.3	231	94.0
		19	9-0803-36	77.9	252	3.23	296	3.80	370	4.75	452	5.80
		25	9-0804-36	58.7	249	4.3	293	5.0	367	6.3	468	8.0
		32	9-0805-36	44.1	240	5.4	282	6.4	353	8.0	431	9.8
		38	9-0806-36	36.3	234	6.5	276	7.6	344	9.5	433	12.0
		44	9-0807-36	30.6	229	7.5	270	8.8	337	11.0	434	14.2
		51	9-0808-36	27.0	234	8.7	275	10.2	344	12.8	460	17.0
		64	9-0810-36	21.7	236	10.9	278	12.8	347	16.0	486	22.0
16	8.5	76	9-0812-36	17.7	229	12.9	269	15.2	336	19.0	469	26.0
		89	9-0814-36	15.1	228	15.1	268	17.8	335	22.3	465	31.0
		305	9-0848-36	4.2	219	51.9	257	61.0	322	76.3	450	107.0
		19	9-1003-36	169.9	549	3.23	646	3.80	807	4.75	968	5.70
		25	9-1004-36	127.3	541	4.3	637	5.0	796	6.3	1012	7.9
		32	9-1005-36	94.0	512	5.4	602	6.4	752	8.0	911	9.7
		38	9-1006-36	75.8	490	6.5	576	7.6	720	9.5	895	11.8
		44	9-1007-36	63.6	476	7.5	559	8.8	699	11.0	887	13.9
20	10	51	9-1008-36	55.5	481	8.7	566	10.2	708	12.8	912	16.4
		64	9-1010-36	43.3	471	10.9	554	12.8	692	16.0	895	21.0
		76	9-1012-36	35.6	459	12.9	540	15.2	675	19.0	885	25.0
		89	9-1014-36	30.3	458	15.1	539	17.8	674	22.3	894	30.0
		102	9-1016-36	26.4	459	17.3	539	20.4	674	25.5	903	34.0
		305	9-1048-36	8.5	443	51.9	521	61.0	652	76.3	907	106.0
		25	9-1204-36	320.5	1362	4.3	1602	5.0	2003	6.3	2087	6.5
		32	9-1205-36	239.9	1305	5.4	1536	6.4	1919	8.0	2050	8.5
20	10	38	9-1206-36	194.4	1256	6.5	1477	7.6	1847	9.5	2099	10.8
		44	9-1207-36	161.8	1210	7.5	1424	8.8	1780	11.0	2073	12.8
		51	9-1208-36	139.6	1210	8.7	1424	10.2	1780	12.8	2105	15.1
		64	9-1210-36	108.8	1183	10.9	1392	12.8	1740	16.0	2101	19.3
		76	9-1212-36	89.7	1159	12.9	1363	15.2	1704	19.0	2137	24.0
		89	9-1214-36	75.7	1145	15.1	1347	17.8	1683	22.3	2106	28.0
		102	9-1216-36	65.3	1133	17.3	1333	20.4	1666	25.5	2080	32.0
		114	9-1218-36	57.4	1113	19.4	1310	22.8	1637	28.5	2063	36.0
		127	9-1220-36	51.7	1115	21.6	1312	25.4	1640	31.8	2088	40.0
		140	9-1222-36	46.6	1109	23.8	1304	28.0	1630	35.0	2071	44.0
		152	9-1224-36	42.6	1100	25.8	1294	30.4	1617	38.0	2059	48.0
		305	9-1248-36	21.0	1090	51.9	1282	61.0	1602	76.3	2085	100.0

ISO Standard Metric

Hole Diam. (mm) A	Rod Diam. (mm) B	Free Length (mm) C	CATALOG NUMBER	RATE Newtons Reqd. to deflect 1 mm	LOAD-DEFLECTION TABLE							
					Total Deflection Recommended for Long Life (17% of C)		Total Deflection Recommended for Avg. Life (20% of C)		Maximum Operating Deflection (25% of C)		Total Travel to Solid	
					Load N	Defl. mm	Load N	Defl. mm	Load N	Defl. mm	Load N	Defl. mm
25	12.5	32	9-1605-36	353.8	1924	5.4	2264	6.4	2830	8.0	3153	8.9
		38	9-1606-36	280.2	1810	6.5	2130	7.6	2662	9.5	3080	11.0
		44	9-1607-36	231.2	1729	7.5	2034	8.8	2543	11.0	3049	13.2
		51	9-1608-36	197.9	1716	8.7	2019	10.2	2523	12.8	3027	15.3
		64	9-1610-36	153.8	1673	10.9	1968	12.8	2460	16.0	3044	19.8
		76	9-1612-36	125.0	1616	12.9	1901	15.2	2376	19.0	3008	24.0
		89	9-1614-36	105.4	1595	15.1	1877	17.8	2346	22.3	2983	28.0
		102	9-1616-36	91.1	1579	17.3	1858	20.4	2322	25.5	2966	33.0
		114	9-1618-36	80.9	1568	19.4	1845	22.8	2306	28.5	3029	37.0
		127	9-1620-36	72.2	1558	21.6	1833	25.4	2291	31.8	3010	42.0
		140	9-1622-36	65.6	1561	24.0	1837	28.0	2296	35.0	3053	47.0
		152	9-1624-36	60.2	1557	25.8	1831	30.4	2289	38.0	3093	51.0
		178	9-1628-36	51.3	1553	30.3	1827	35.6	2283	44.5	3102	61.0
		203	9-1632-36	44.7	1541	34.5	1813	40.6	2266	50.8	3112	70.0
305	9-1648-36	29.6	1535	51.9	1805	61.0	2257	76.3	3131	106.0		
32	16	38	9-2006-36	488.6	3156	6.5	3713	7.6	4642	9.5	4860	10.0
		44	9-2007-36	404.6	3026	7.5	3560	8.8	4450	11.0	4930	12.2
		51	9-2008-36	345.0	2991	8.7	3519	10.2	4399	12.8	4979	14.5
		64	9-2010-36	266.2	2896	10.9	3407	12.8	4259	16.0	5068	19.0
		76	9-2012-36	215.4	2783	12.9	3274	15.2	4093	19.0	4987	23.0
		89	9-2014-36	182.1	2756	15.1	3242	17.8	4053	22.3	5030	28.0
		102	9-2016-36	155.7	2700	17.3	3176	20.4	3970	25.5	4892	31.0
		114	9-2018-36	135.7	2630	19.4	3095	22.8	3868	28.5	4764	35.0
		127	9-2020-36	121.9	2632	21.6	3096	25.4	3870	31.8	4849	40.0
		140	9-2022-36	111.0	2651	24.0	3119	28.0	3898	35.0	5018	45.0
		152	9-2024-36	100.9	2607	25.8	3067	30.4	3833	38.0	4929	49.0
		178	9-2028-36	85.6	2591	30.3	3049	35.6	3811	44.5	4886	57.0
		203	9-2032-36	74.6	2575	34.5	3029	40.6	3786	50.8	4941	66.0
		254	9-2040-36	59.5	2571	43.2	3025	50.8	3781	63.5	5017	84.0
305	9-2048-36	49.6	2570	51.9	3023	61.0	3779	76.3	5068	102.0		
40	20	51	9-2408-36	558.7	4844	8.7	5698	10.2	7123	12.8	7815	14.0
		64	9-2410-36	422.1	4592	10.9	5402	12.8	6753	16.0	7675	18.2
		76	9-2412-36	338.0	4367	12.9	5138	15.2	6422	19.0	7551	22.0
		89	9-2414-36	280.2	4240	15.1	4988	17.8	6235	22.3	7276	26.0
		102	9-2416-36	243.4	4221	17.3	4966	20.4	6208	25.5	7604	31.0
		114	9-2418-36	213.7	4141	19.4	4871	22.8	6089	28.5	7560	35.0
		127	9-2420-36	189.1	4084	21.6	4804	25.4	6005	31.8	7503	40.0
		140	9-2422-36	171.0	4066	24.0	4783	28.0	5979	35.0	7477	44.0
		152	9-2424-36	155.3	4014	25.8	4722	30.4	5903	38.0	7439	48.0
		178	9-2428-36	131.0	3975	30.3	4676	35.6	5845	44.5	7394	56.0
		203	9-2432-36	113.8	3928	34.5	4622	40.6	5777	50.8	7361	65.0
		254	9-2440-36	90.4	3902	43.2	4591	50.8	5738	63.5	7450	82.0
		305	9-2448-36	75.0	3886	51.9	4572	61.0	5715	76.3	7500	100.0
		50	25	64	9-3210-36	725.0	7888	10.9	9281	12.8	11601	16.0
76	9-3212-36			572.7	7399	12.9	8705	15.2	10881	19.0	12200	21.0
89	9-3214-36			474.6	7181	15.1	8448	17.8	10560	22.3	11981	25.0
102	9-3216-36			404.6	7015	17.3	8253	20.4	10316	25.5	11827	29.0
114	9-3218-36			352.0	6822	19.4	8026	22.8	10032	28.5	11761	33.0
127	9-3220-36			313.5	6768	21.6	7963	25.4	9953	31.8	11666	37.0
140	9-3222-36			282.0	6722	23.8	7908	28.0	9885	35.0	11825	42.0
152	9-3224-36			253.9	6562	25.8	7720	30.4	9650	38.0	11530	45.0
178	9-3228-36			215.0	6503	30.3	7650	35.6	9563	44.5	11466	53.0
203	9-3232-36			185.6	6406	34.5	7537	40.6	9421	50.8	11394	61.0
254	9-3240-36			146.2	6314	43.2	7429	50.8	9286	63.5	11316	77.0
305	9-3248-36			120.7	6257	51.9	7361	61.0	9201	76.3	11265	93.0

DieMax XL™ Round Wire Die Springs

Inch Sizes Round Wire Construction

- ◆ Available in light, medium and heavy load ratings
- ◆ Manufactured with Chromium Alloy steel
- ◆ Uniform hole and rod sizes matched to conventional sizes
- ◆ SPC quality assurance
- ◆ Our quality means extra long life and reliable performance

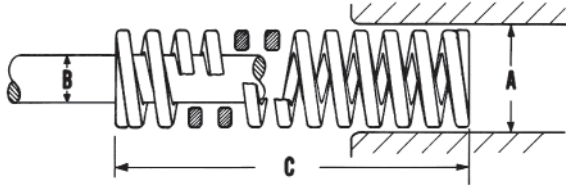

Light Load Springs: Green

Hole Diam. (in) A	Rod Diam. (in) B	Free Length (in) C	CATALOG NUMBER	RATE Pounds Req'd. to deflect 1/10 in.	LOAD-DEFLECTION TABLE							
					Total Deflection Recommended for Long Life (25% of C)		Total Deflection Recommended for Avg. Life (30% of C)		Maximum Operating Deflection (40% of C)		Total Travel to Solid	
					Load lbs.	Defl. in.	Load lbs.	Defl. in.	Load lbs.	Defl. in.	Load lbs.	Defl. in.
3/8	3/16	3/4	9-0603-119	3.35	6	0.19	8	0.23	10	0.30	13	0.39
		1	9-0604-119	2.52	6	0.25	8	0.30	10	0.40	13	0.52
		1 1/4	9-0605-119	1.96	6	0.31	7	0.38	10	0.50	13	0.65
		1 1/2	9-0606-119	1.59	6	0.38	7	0.45	10	0.60	12	0.78
		1 3/4	9-0607-119	1.35	6	0.44	7	0.53	9	0.70	12	0.91
		2	9-0608-119	1.19	6	0.50	7	0.60	9	0.80	13	1.06
		2 1/2	9-0610-119	0.93	6	0.63	7	0.75	9	1.00	12	1.31
		3	9-0612-119	0.76	6	0.75	7	0.90	9	1.20	12	1.56
1/2	9/32	3/4	9-0803-119	6.45	12	0.19	15	0.23	19	0.30	24	0.37
		1	9-0804-119	4.88	12	0.25	15	0.30	20	0.40	26	0.53
		1 1/4	9-0805-119	3.71	12	0.31	14	0.38	19	0.50	25	0.66
		1 1/2	9-0806-119	3.04	11	0.38	14	0.45	18	0.60	24	0.80
		1 3/4	9-0807-119	2.54	11	0.44	13	0.53	18	0.70	24	0.94
		2	9-0808-119	2.17	11	0.5	13	0.60	17	0.80	23	1.06
		2 1/2	9-0810-119	1.68	11	0.63	13	0.75	17	1.00	22	1.31
		3	9-0812-119	1.43	11	0.75	13	0.90	17	1.20	23	1.62
5/8	11/32	3 1/2	9-0814-119	1.22	11	0.88	13	1.05	17	1.40	23	1.90
		12	9-0848-119	0.34	10	3.00	12	3.60	16	4.80	21	6.41
		3/4	9-1003-119	13.50	25	0.19	30	0.23	41	0.30	58	0.43
		1	9-1004-119	10.2	25	0.25	31	0.30	41	0.40	59	0.58
		1 1/4	9-1005-119	7.7	24	0.31	29	0.38	38	0.50	56	0.73
		1 1/2	9-1006-119	6.0	23	0.38	27	0.45	36	0.60	53	0.88
		1 3/4	9-1007-119	5.0	22	0.44	26	0.53	35	0.70	51	1.02
		2	9-1008-119	4.33	22	0.50	26	0.60	35	0.80	51	1.18
		2 1/2	9-1010-119	3.38	21	0.63	25	0.75	34	1.00	50	1.49
		3	9-1012-119	2.73	20	0.75	25	0.90	33	1.20	49	1.78
		3 1/2	9-1014-119	2.31	20	0.88	24	1.05	32	1.40	48	2.08
		4	9-1016-119	2.01	20	1.00	24	1.20	32	1.60	48	2.39
12	9-1048-119	0.64	19	3.00	23	3.60	31	4.80	46	7.24		

DieMax XL™ Round Wire Die Springs

Medium Load Springs: Blue

Hole Diam. (in) A	Rod Diam. (in) B	Free Length (in) C	CATALOG NUMBER	RATE Pounds Req'd. to deflect 1/10 in.	LOAD-DEFLECTION TABLE							
					Total Deflection Recommended for Long Life (25% of C)		Total Deflection Recommended for Avg. Life (30% of C)		Maximum Operating Deflection (37.5% of C)		Total Travel to Solid	
					Load lbs.	Defl. in.	Load lbs.	Defl. in.	Load lbs.	Defl. in.	Load lbs.	Defl. in.
3/8	3/16	3/4	9-0603-219	9.0	17	0.19	20	0.23	25	0.28	28	0.31
		1	9-0604-219	7.0	17	0.25	21	0.30	26	0.38	29	0.41
		1 1/4	9-0605-219	5.4	17	0.31	20	0.38	26	0.47	29	0.52
		1 1/2	9-0606-219	4.43	17	0.38	20	0.45	25	0.56	28	0.63
		1 3/4	9-0607-219	3.73	16	0.44	20	0.53	24	0.66	27	0.73
		2	9-0608-219	3.22	16	0.50	19	0.60	24	0.75	27	0.83
		2 1/2	9-0610-219	2.55	16	0.63	19	0.75	24	0.94	27	1.04
		3	9-0612-219	2.10	16	0.75	19	0.90	24	1.13	26	1.25
1/2	9/32	3/4	9-0803-219	16.5	31	0.19	37	0.23	46	0.28	53	0.32
		1	9-0804-219	12.4	31	0.25	37	0.30	47	0.38	54	0.44
		1 1/4	9-0805-219	9.6	30	0.31	36	0.38	45	0.47	53	0.55
		1 1/2	9-0806-219	7.9	30	0.38	36	0.45	45	0.56	54	0.68
		1 3/4	9-0807-219	6.6	29	0.44	35	0.53	43	0.66	51	0.78
		2	9-0808-219	5.7	29	0.5	34	0.60	43	0.75	52	0.90
		2 1/2	9-0810-219	4.45	28	0.63	33	0.75	42	0.94	50	1.12
		3	9-0812-219	3.66	27	0.75	33	0.90	41	1.13	49	1.35
5/8	11/32	3/4	9-1003-219	24.0	45	0.19	54	0.23	68	0.28	74	0.31
		1	9-1004-219	18.2	46	0.25	55	0.30	68	0.38	78	0.43
		1 1/4	9-1005-219	13.7	43	0.31	51	0.38	64	0.47	74	0.54
		1 1/2	9-1006-219	11.1	42	0.38	50	0.45	62	0.56	72	0.65
		1 3/4	9-1007-219	9.2	40	0.44	48	0.53	61	0.66	70	0.76
		2	9-1008-219	7.90	40	0.50	47	0.60	59	0.75	69	0.87
		2 1/2	9-1010-219	6.10	38	0.63	46	0.75	58	0.94	66	1.08
		3	9-1012-219	5.00	38	0.75	45	0.90	57	1.13	65	1.30
		3 1/2	9-1014-219	4.28	37	0.88	45	1.05	56	1.31	65	1.52
		4	9-1016-219	3.73	37	1.00	45	1.20	56	1.50	65	1.75
		12	9-1048-219	1.19	36	3.00	43	3.60	54	4.50	63	5.26

Heavy Load Springs: Red

Hole Diam. (in) A	Rod Diam. (in) B	Free Length (in) C	CATALOG NUMBER	RATE Pounds Req'd. to deflect 1/10 in.	LOAD-DEFLECTION TABLE							
					Total Deflection Recommended for Long Life (20% of C)		Total Deflection Recommended for Avg. Life (25% of C)		Maximum Operating Deflection (30% of C)		Total Travel to Solid	
					Load lbs.	Defl. in.	Load lbs.	Defl. in.	Load lbs.	Defl. in.	Load lbs.	Defl. in.
3/8	3/16	3/4	9-0603-269	15.7	24	0.15	29	0.19	35	0.23	39	0.25
		1	9-0604-269	11.8	24	0.20	29	0.25	35	0.30	40	0.34
		1 1/4	9-0605-269	9.2	23	0.25	29	0.31	34	0.38	40	0.43
		1 1/2	9-0606-269	7.4	22	0.30	28	0.38	33	0.45	38	0.52
		1 3/4	9-0607-269	6.2	22	0.35	27	0.44	32	0.53	36	0.58
		2	9-0608-269	5.5	22	0.40	27	0.50	33	0.60	38	0.70
		2 1/2	9-0610-269	4.38	22	0.50	27	0.63	33	0.75	39	0.90
		3	9-0612-269	3.59	22	0.60	27	0.75	32	0.90	38	1.06
1/2	9/32	3/4	9-0803-269	28.5	43	0.15	53	0.19	64	0.23	71	0.25
		1	9-0804-269	21.4	43	0.20	54	0.25	64	0.30	75	0.35
		1 1/4	9-0805-269	16.5	41	0.25	52	0.31	62	0.38	73	0.44
		1 1/2	9-0806-269	13.4	40	0.30	50	0.38	60	0.45	72	0.54
		1 3/4	9-0807-269	11.2	39	0.35	49	0.44	59	0.53	70	0.62
		2	9-0808-269	9.9	39	0.40	49	0.50	59	0.60	73	0.74
		2 1/2	9-0810-269	7.7	39	0.50	48	0.63	58	0.75	72	0.93
		3	9-0812-269	6.4	38	0.60	48	0.75	57	0.90	71	1.12
5/8	11/32	3/4	9-1003-269	62.0	93	0.15	116	0.19	140	0.23	161	0.26
		1	9-1004-269	46.6	93	0.20	117	0.25	140	0.30	168	0.36
		1 1/4	9-1005-269	35.0	87	0.25	109	0.31	131	0.38	159	0.45
		1 1/2	9-1006-269	28.5	86	0.30	107	0.38	128	0.45	160	0.56
		1 3/4	9-1007-269	23.3	82	0.35	102	0.44	122	0.53	149	0.64
		2	9-1008-269	20.3	81	0.40	101	0.50	122	0.60	151	0.74
		2 1/2	9-1010-269	15.9	79	0.50	99	0.63	119	0.75	149	0.94
		3	9-1012-269	13.0	78	0.60	98	0.75	117	0.90	149	1.14
		3 1/2	9-1014-269	11.2	78	0.70	98	0.88	117	1.05	151	1.35
		4	9-1016-269	9.7	77	0.80	97	1.00	116	1.20	150	1.55
		12	9-1048-269	3.09	74	2.40	93	3.00	111	3.60	145	4.68

Spring Accessories

Spring Cages

- ◆ These spring cages enhance die spring life by providing a flat, hardened die pocket for spring operation.
- ◆ Cages are available for metric and inch spring diameters from 3/4" - 2" (20mm - 50mm).
- ◆ Accommodate standard metric and inch guiding rods and drill diameters.
- ◆ Material: 0.049" / 1.245mm cold rolled steel.
- ◆ Conforms to NAAMS standards.

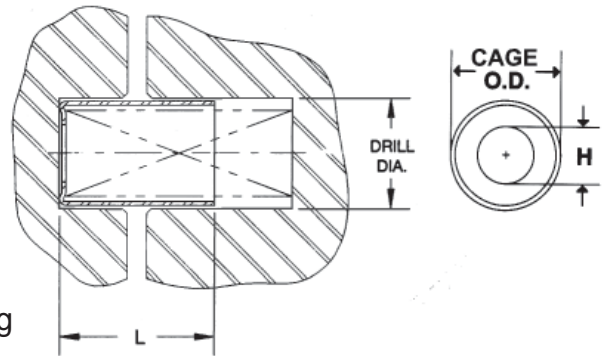

Spring Diameter		Drill Diameter		Cage O.D.		Clearance for Rod (H)	
inches	mm	inches	mm	inches	mm	inches	mm
3/4	20	29/32	24	0.86	21.7	7/16	11
1	25	1-5/32	30	1.11	28.1	9/16	14
1-1/4	32	1-13/32	36	1.36	34.4	3/4	19
1-1/2	40	1-21/32	43	1.61	40.8	31/32	25
2	50	2-5/32	56	2.11	53.5	1-3/8	35

Length L		3/4 in. & 20mm Diameter Springs		1 in. & 25mm Diameter Springs		1-1/4 in. & 32mm Diameter Springs		1-1/2 in. & 40mm Diameter Springs		2 in. & 50mm Diameter Springs	
(in)	(mm)	Danly Part No.	NAAMS Code	Danly Part No.	NAAMS Code	Danly Part No.	NAAMS Code	Danly Part No.	NAAMS Code	Danly Part No.	NAAMS Code
1	25	6-8	S212025	8-8	S212525	10-8	S213225	12-8	S214025	16-8	S215025
1-1/4	32	6-10	S212032	8-10	S212532	10-10	S213232	12-10	S214032	16-10	S215032
1-1/2	38	6-12	S212038	8-12	S212538	10-12	S213238	12-12	S214038	16-12	S215038
1-3/4	44	6-14	S212044	8-14	S212544	10-14	S213244	12-14	S214044	16-14	S215044
2	51	6-16	S212051	8-16	S212551	10-16	S213251	12-16	S214051	16-16	S215051
2-1/4	57	6-18	-	8-18	-	10-18	-	12-18	-	16-18	-
2-1/2	64	6-20	S212064	8-20	S212564	10-20	S213264	12-20	S214064	16-20	S215064
2-3/4	70	6-22	-	8-22	-	10-22	-	12-22	-	16-22	-
3	76	6-24	S212076	8-24	S212576	10-24	S213276	12-24	S214076	16-24	S215076
3-1/4	83	6-26	-	8-26	-	10-26	-	12-26	-	16-26	-
3-1/2	89	6-28	S212089	8-28	S212589	10-28	S213289	12-28	S214089	16-28	S215089
3-3/4	95	6-30	-	8-30	-	10-30	-	12-30	-	16-30	-
4	102	6-32	S212010	8-32	S212510	10-32	S213210	12-32	S214010	16-32	S215010
4-1/4	108	6-34	-	8-34	-	10-34	-	12-34	-	16-34	-
4-1/2	114	6-36	-	8-36	-	10-36	-	12-36	-	16-36	-
4-3/4	121	6-38	-	8-38	-	10-38	-	12-38	-	16-38	-
5	127	6-40	S212012	8-40	S212512	10-40	S213212	12-40	S214012	16-40	S215012
5-1/2	140	6-44	-	8-44	-	10-44	-	12-44	-	16-44	-
6	152	6-48	S212015	8-48	S212515	10-48	S213215	12-48	S214015	16-48	S215015
6-1/2	165	6-52	-	8-52	-	10-52	-	12-52	-	16-52	-
7	178	6-56	S212017	8-56	S212517	10-56	S213217	12-56	S214017	16-56	S215017
8	203	6-64	S212020	8-64	S212520	10-64	S213220	12-64	S214020	16-64	S215020
9	229	-	-	-	-	10-72	S213222	12-72	S214022	16-72	S215022
10	254	-	-	-	-	10-80	-	12-80	-	16-80	-
11	280	-	-	-	-	-	-	-	-	16-88	S215028
12	305	-	-	-	-	-	-	-	-	16-96	S215030

Spring Accessories

Spring Retainers

- ◆ These spring retainers hold individual springs firmly in position while the die is being assembled or disassembled. Pre-loading the spring is easy since the springs can be set individually, which avoids working against the combined force of the springs.
- ◆ Available for springs 1-1/4" (32mm), 1-1/2" (38mm) and 2" (50mm) diameters and any free length where clearance permits.
- ◆ Material: steel

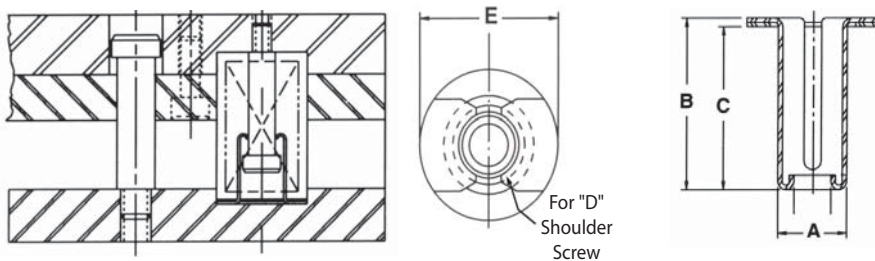

9-0615-16

Catalog Number	Spring Diameter		Rod Diameter A		B		C		Shoulder Screw D		E	
	in	mm	in	mm	in	mm	in	mm	in	mm	in	mm
9-0615-16	1-1/2	38	3/4	19	1-7/8	48	1-3/4	44	3/8	—	1-7/16	37
9-0815-16	2	51	1	25	1-3/4	48	1-3/4	44	1/2	M12	1-5/16	33
9-0823-16	2	51	1	25	2-7/8	73	2-3/4	70	1/2	M12	1-5/16	33

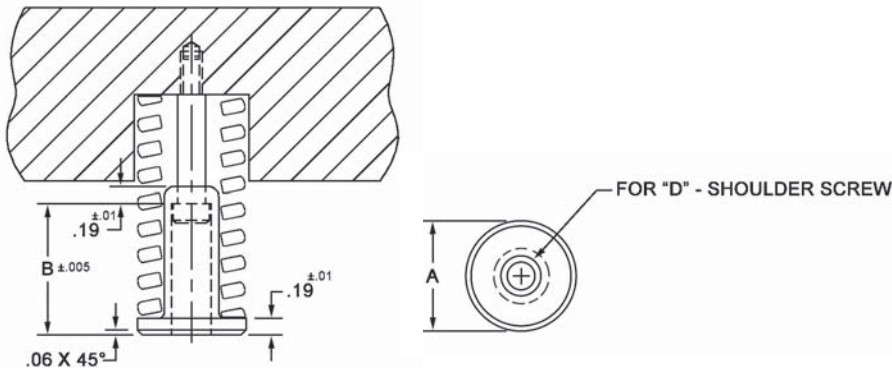

SR125150

Catalog Number	Spring Diameter		Rod Diameter A		B		C		Shoulder Screw D		E	
	in	mm	in	mm	in	mm	in	mm	in	mm	in	mm
SR125150	1-1/4	32	5/8	16	1-11/16	43	1-1/2	38	5/16	M8	1-1/4	32
SR125200					2-3/16	56	2	51	5/16	M8	1-1/4	32
SR125250					2-11/16	68	2-1/2	64	5/16	M8	1-1/4	32
SR150150	1-1/2	38	3/4	19	1-11/16	43	1-1/2	38	3/8	M10	1-1/2	38
SR150200					2-3/16	56	2	51	3/8	M10	1-1/2	38
SR150250					2-11/16	68	2-1/2	64	3/8	M10	1-1/2	38
SR200150	2	51	1	25	1-11/16	43	1-1/2	38	1/2	M13	2	51
SR200200					2-3/16	56	2	51	1/2	M13	2	51
SR200250					2-11/16	68	2-1/2	64	1/2	M13	2	51

Spring Accessories

Spring Guards

- ◆ Spring guards hold individual springs firmly in position
- ◆ Available for springs 1-1/4" (32mm), 1-1/2" (38mm) and 2" (50mm) diameters and any free length where clearance permits
- ◆ Material: 0.049" / 1.24mm cold rolled steel with painted finish

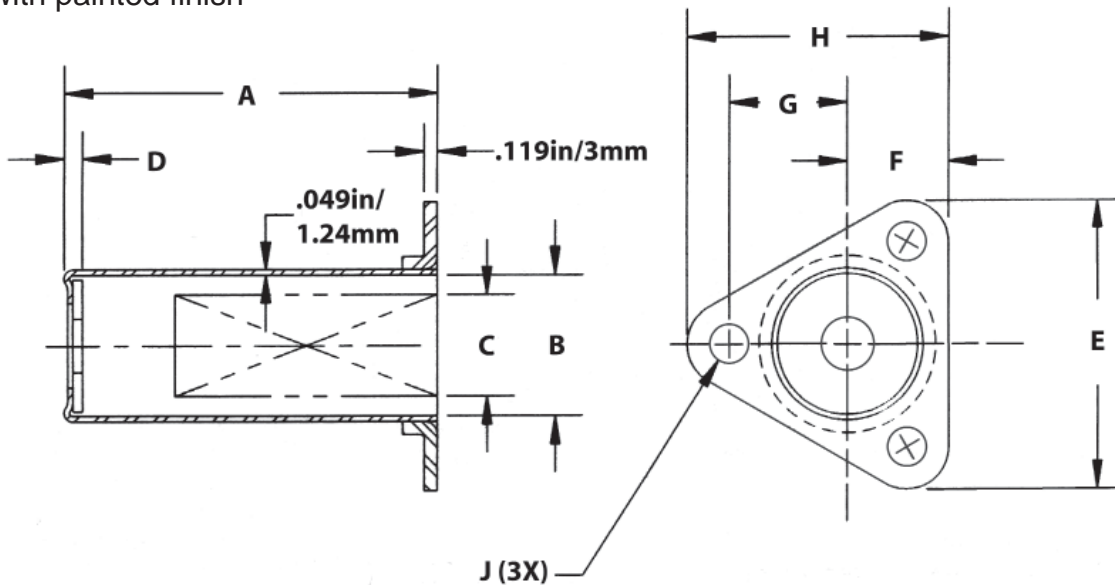

Catalog Number	A		Max Spring Dia B		Recommended Spring Dia C		D		E		F		G		H		J	
	in	mm	in	mm	in	mm	in	mm	in	mm	in	mm	in	mm	in	mm	in	mm
10-24G	3	76	1-1/4	32	1	25	3/16	5	2-19/32	66	29/32	23	1-1/16	27	2-11/32	60	11/32	9
10-32G	4	102																
10-40G	5	127																
10-48G	6	152																
10-56G	7	178																
12-24G	3	76	1-1/2	38	1-1/4	32	3/16	5	2-15/16	75	1	25	1-1/4	32	2-5/8	67	11/32	9
12-32G	4	102																
12-40G	5	127																
12-48G	6	152																
12-56G	7	178																
12-64G	8	203																
12-80G	10	254																
16-32G	4	102	2	51	1-1/2	38	1/4	6	3-11/16	94	1-1/4	32	1-5/8	41	3-11/32	85	7/16	11
16-40G	5	127																
16-48G	6	152																
16-56G	7	178																
16-64G	8	203																
16-68G	9	229																
16-80G	10	254																
16-96G	12	305																

Compression Spring Special Requirement Quote Sheet

Company Information

Company: _____
Contact: _____ Title: _____
Address: _____
Address: _____
City: _____ State: _____ Zip: _____
Phone: _____ Fax: _____

Sales Requirements

Estimated Annual Volume: _____ Order Quantity: _____
Delivery Date Required: _____

Compression Spring Specifications

Spring Material: _____ Wire Size: _____
Outside Diameter: _____ Inside Diameter: _____
Free Length: _____ Maximum Solid Height: _____
Ends (Closed & Ground or Closed & Unground: _____

Specify One of the Next Three Attributes

Total Coils: _____ Spring Rate: _____
Load at a Given Rate: _____

Application Explanation

Finish (Painted, Unpainted, Plating)

Critical Tolerances, Certifications or Inspections Required

Notes

DieMax XL™

Maximum Life Springs



www.danly.com

The Danly IEM Value Proposition

- I. **DANLY IEM** is recognized as the leader in manufacturing quality die components to the global parts forming industry. Our reputation has been built by satisfying customer needs, and we are very strong in the automotive and appliance industries.
- II. **DANLY IEM** offers outstanding delivery on a consistent basis. Choosing us as a supplier means that our customers have a competitive advantage in delivering their products to the market.
- III. **DANLY IEM** has complex machining capabilities on die components at several facilities. With extensive machining capabilities in the USA and China, we have taken the lead role in creating and bringing new products to customers and helping them find solutions that improve their operations.
- IV. **DANLY IEM's** vast breadth of products assures innovative solutions. We strive to address customer problems by utilizing our research and development department as well as other technical professionals.
- V. **DANLY IEM** has a technically trained sales force and distributor channels with Engineering support. Sales, Marketing and Engineering professionals are available to support our product lines.

- **Competitive Prices**
- **Reliability and Performance**

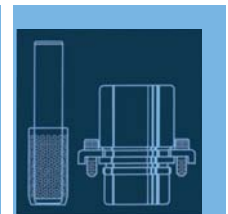

**...A LEADING MANUFACTURER
AND INNOVATOR OF DIE
COMPONENTS SUPPLIED
GLOBALLY TO THE METAL
FORMING INDUSTRY...**

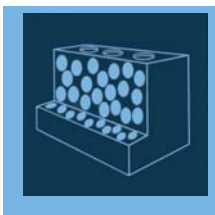
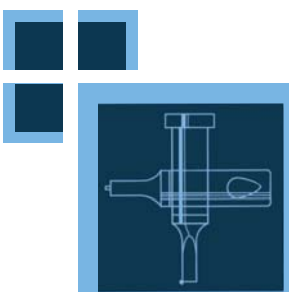

- **High Quality Design & Construction**
- **Outstanding Service & Support**

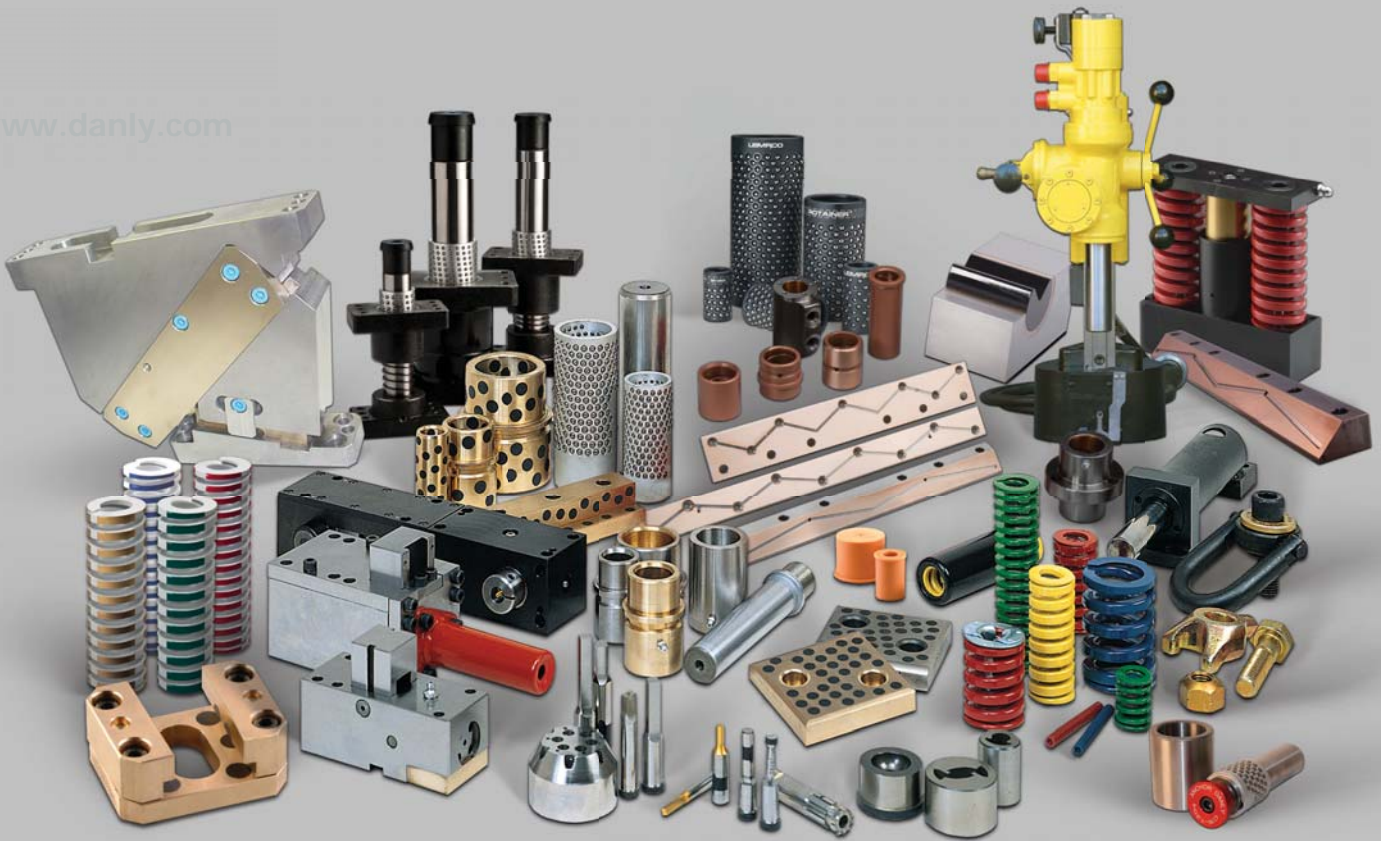

DieMax XL™ Maximum Life Springs



Distributed by:

www.danly.com
info@anchorlamina.com

WITHIN THE USA & CANADA

CALL: 800-652-6462

FAX: 800-406-4410

OUTSIDE THE USA & CANADA

CALL: 248-489-7816

FAX: 248-553-6842



Registered
to ISO 9001